

PRODUCT FEATURES

- High level of integration
- IGBT CHIP(Trench+Field Stop technology)
- Low saturation voltage and positive temperature coefficient
- Fast switching and short tail current
- Free wheeling diodes with fast and soft reverse recovery
- Industry standard package with insulated copper base plate and soldering pins for PCB mounting
- Temperature sense included

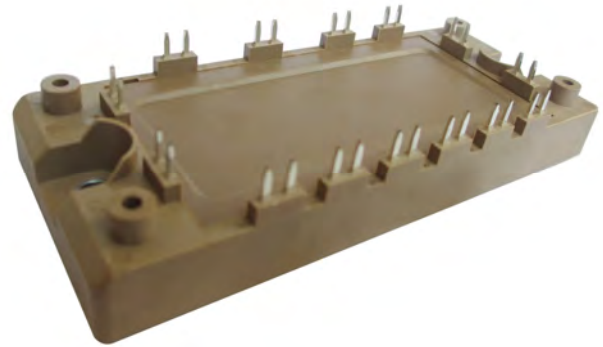

APPLICATIONS

- AC motor control
- Motion/servo control
- Inverter and power supplies

IGBT-inverter

ABSOLUTE MAXIMUM RATINGS($T_C=25^\circ\text{C}$ unless otherwise specified)

Symbol	Parameter/Test Conditions		Values	Unit
V_{CES}	Collector Emitter Voltage	$T_J=25^\circ\text{C}$	1200	V
V_{GES}	Gate Emitter Voltage		± 20	
I_C	DC Collector Current	$T_C=25^\circ\text{C}$	115	A
		$T_C=100^\circ\text{C}$	75	
I_{CM}	Repetitive Peak Collector Current	$t_p=1\text{ms}$	150	
P_{tot}	Power Dissipation Per IGBT		440	W

Diode-inverter

ABSOLUTE MAXIMUM RATINGS ($T_C=25^\circ\text{C}$ unless otherwise specified)

Symbol	Parameter/Test Conditions		Values	Unit
V_{RRM}	Repetitive Reverse Voltage	$T_J=25^\circ\text{C}$	1200	V
$I_{F(AV)}$	Average Forward Current	$T_C=25^\circ\text{C}$	75	A
I_{FRM}	Repetitive Peak Forward Current	$t_p=1\text{ms}$	150	
i^2t		$T_J=125^\circ\text{C}$, $t=10\text{ms}$, $V_R=0\text{V}$	1800	A^2S

MacMic Science & Technology Co., Ltd.

Add: #18, Hua Shan Zhong Lu, New District, Changzhou City, Jiangsu Province, P. R. of China
 Tel.: +86-519-85163708 Fax: +86-519-85162291 Post Code: 213022 Website: www.macmicst.com

IGBT-inverter

ELECTRICAL CHARACTERISTICS ($T_C=25^\circ\text{C}$ unless otherwise specified)

Symbol	Parameter/Test Conditions		Min.	Typ.	Max.	Unit
$V_{GE(th)}$	Gate Emitter Threshold Voltage	$V_{CE}=V_{GE}, I_C=3\text{mA}$	5.0	5.8	6.5	V
$V_{CE(sat)}$	Collector Emitter Saturation Voltage	$I_C=75\text{A}, V_{GE}=15\text{V}, T_J=25^\circ\text{C}$		1.85	2.3	
		$I_C=75\text{A}, V_{GE}=15\text{V}, T_J=125^\circ\text{C}$		2.15		
		$I_C=75\text{A}, V_{GE}=15\text{V}, T_J=150^\circ\text{C}$		2.25		
I_{CES}	Collector Leakage Current	$V_{CE}=1200\text{V}, V_{GE}=0\text{V}, T_J=25^\circ\text{C}$			100	μA
		$V_{CE}=1200\text{V}, V_{GE}=0\text{V}, T_J=150^\circ\text{C}$			10	mA
I_{GES}	Gate Leakage Current	$V_{CE}=0\text{V}, V_{GE}=\pm 15\text{V}, T_J=25^\circ\text{C}$	-400		400	nA
R_{gint}	Integrated Gate Resistor			10		Ω
Q_g	Gate Charge	$V_{CE}=600\text{V}, I_C=75\text{A}, V_{GE}=15\text{V}$		0.39		μC
C_{ies}	Input Capacitance	$V_{CE}=25\text{V}, V_{GE}=0\text{V}, f=1\text{MHz}$		11		nF
C_{res}	Reverse Transfer Capacitance				100	
$t_{d(on)}$	Turn on Delay Time	$V_{CC}=600\text{V}, I_C=75\text{A}$ $R_G=7.5\Omega,$ $V_{GE}=\pm 15\text{V},$ Inductive Load	$T_J=25^\circ\text{C}$		300	ns
			$T_J=125^\circ\text{C}$		310	ns
			$T_J=150^\circ\text{C}$		310	ns
t_r	Rise Time		$T_J=25^\circ\text{C}$		78	ns
			$T_J=125^\circ\text{C}$		82	ns
			$T_J=150^\circ\text{C}$		84	ns
$t_{d(off)}$	Turn off Delay Time	$T_J=25^\circ\text{C}$		320	ns	
		$T_J=125^\circ\text{C}$		350	ns	
		$T_J=150^\circ\text{C}$		360	ns	
t_f	Fall Time	$T_J=25^\circ\text{C}$		80	ns	
		$T_J=125^\circ\text{C}$		150	ns	
		$T_J=150^\circ\text{C}$		160	ns	
E_{on}	Turn on Energy	$T_J=125^\circ\text{C}$		9.2	mJ	
		$T_J=150^\circ\text{C}$		10.1	mJ	
E_{off}	Turn off Energy	$T_J=125^\circ\text{C}$		6.7	mJ	
		$T_J=150^\circ\text{C}$		7.0	mJ	
I_{sc}	Short Circuit Current	$t_{psc}\leq 10\mu\text{s}, V_{GE}=15\text{V}$ $T_J=125^\circ\text{C}, V_{CC}=600\text{V}$		450		A
R_{thJC}	Junction to Case Thermal Resistance (Per IGBT)				0.34	K/W

Diode-inverter

ELECTRICAL CHARACTERISTICS ($T_C=25^\circ\text{C}$ unless otherwise specified)

Symbol	Parameter/Test Conditions		Min.	Typ.	Max.	Unit
V_F	Forward Voltage	$I_F=75\text{A}, V_{GE}=0\text{V}, T_J=25^\circ\text{C}$		1.9	2.4	V
		$I_F=75\text{A}, V_{GE}=0\text{V}, T_J=125^\circ\text{C}$		1.65		
		$I_F=75\text{A}, V_{GE}=0\text{V}, T_J=150^\circ\text{C}$		1.6		
t_{rr}	Reverse Recovery Time	$I_F=75\text{A}, V_R=600\text{V}$		360		ns
I_{RRM}	Max. Reverse Recovery Current	$di_F/dt=-1000\text{A}/\mu\text{s}$		68		A
Q_{RR}	Reverse Recovery Charge	$T_J=150^\circ\text{C}$		12.8		μC
E_{rec}	Reverse Recovery Energy			4.5		mJ
R_{thJCD}	Junction to Case Thermal Resistance (Per Diode)				0.6	K/W

NTC CHARACTERISTICS ($T_C=25^\circ\text{C}$ unless otherwise specified)

Symbol	Parameter/Test Conditions	Min.	Typ.	Max.	Unit
R_{25}	Resistance $T_C=25^\circ\text{C}$		5		$\text{K}\Omega$
$B_{25/50}$	$R_2 = R_{25} \exp [B_{25/50}(1/T_2 - 1/(298.15 \text{ K}))]$		3375		K

MODULE CHARACTERISTICS ($T_C=25^\circ\text{C}$ unless otherwise specified)

Symbol	Parameter/Test Conditions	Values	Unit	
T_{Jmax}	Max. Junction Temperature	175	$^\circ\text{C}$	
T_{Jop}	Operating Temperature	-40~150		
T_{stg}	Storage Temperature	-40~125		
V_{isol}	Isolation Breakdown Voltage	AC, 50Hz(R.M.S), t=1minute	3000	V
CTI	Comparative Tracking Index		>200	
Md	Mounting Torque	Recommended (M5)	2.5~5	Nm
Weight			180	g

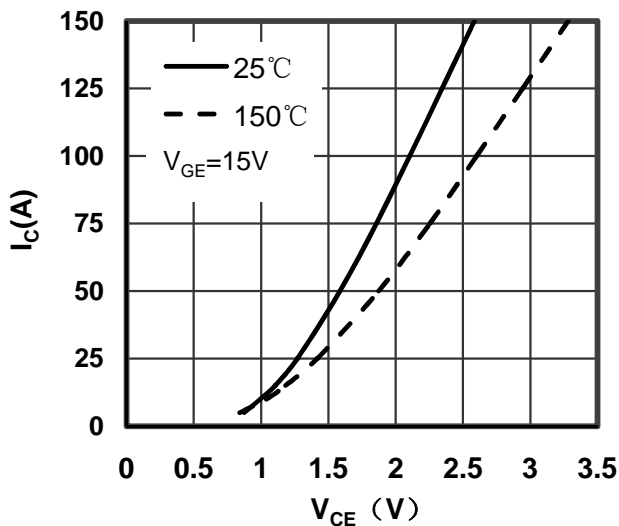

Figure 1. Typical Output Characteristics IGBT-inverter

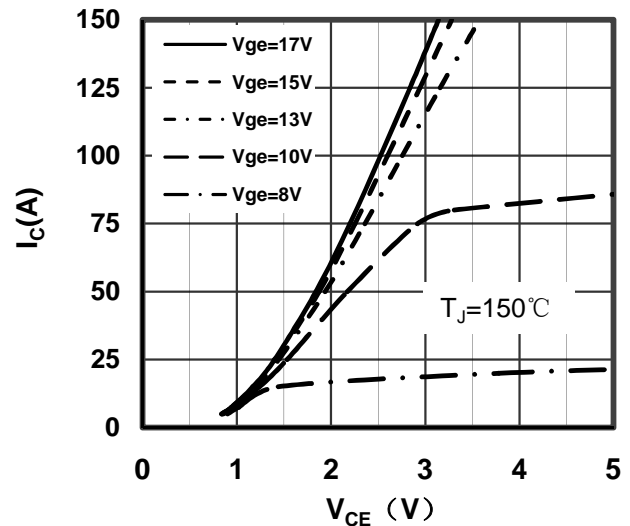

Figure 2. Typical Output Characteristics IGBT-inverter

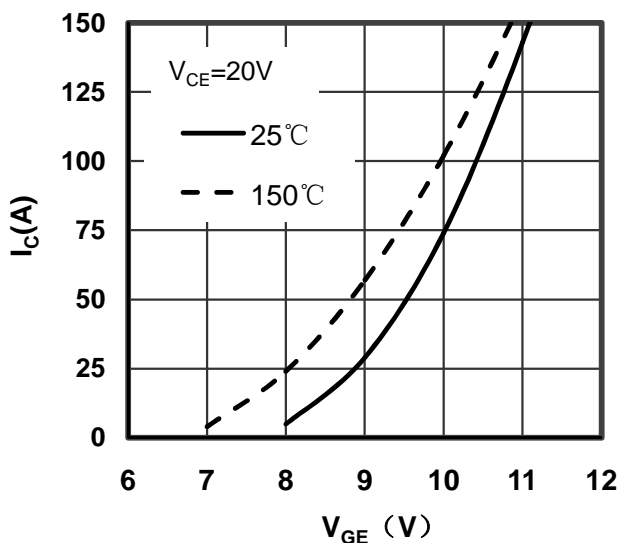

Figure 3. Typical Transfer Characteristics IGBT-inverter

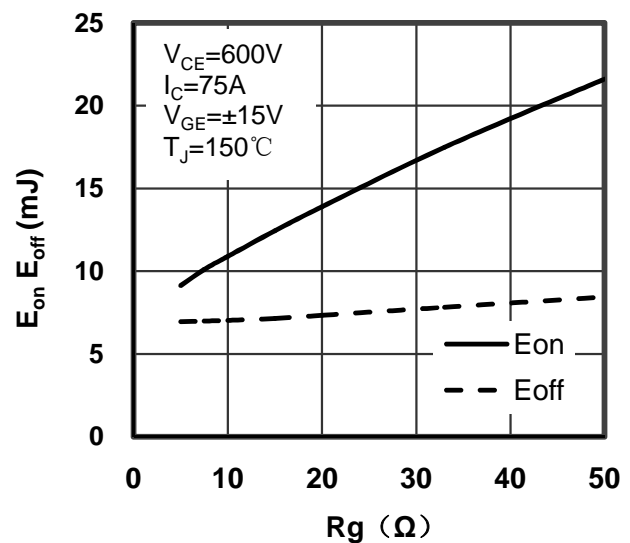

Figure 4. Switching Energy vs Gate Resistor IGBT-inverter

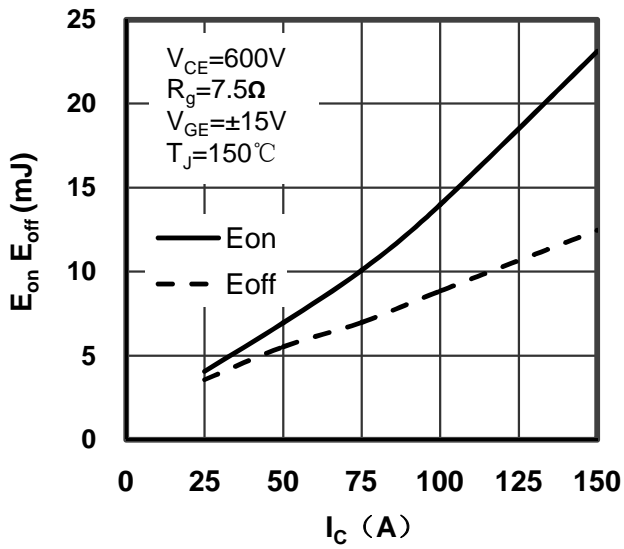

Figure 5. Switching Energy vs Collector Current IGBT-inverter

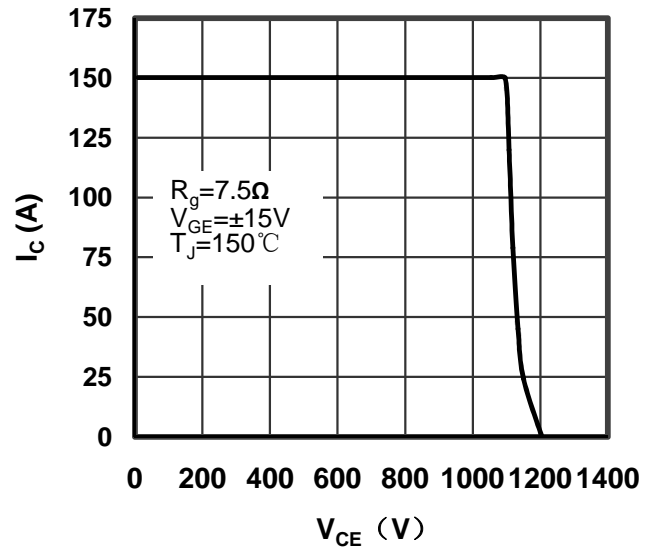

Figure 6. Reverse Biased Safe Operating Area IGBT-inverter

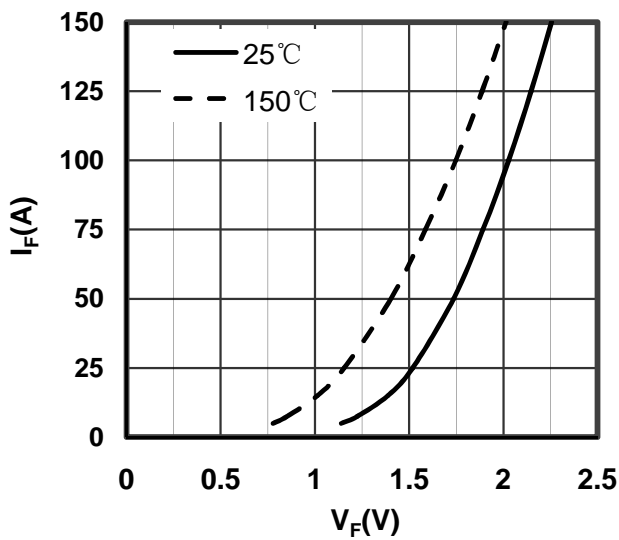

Figure 7. Diode Forward Characteristics Diode-inverter

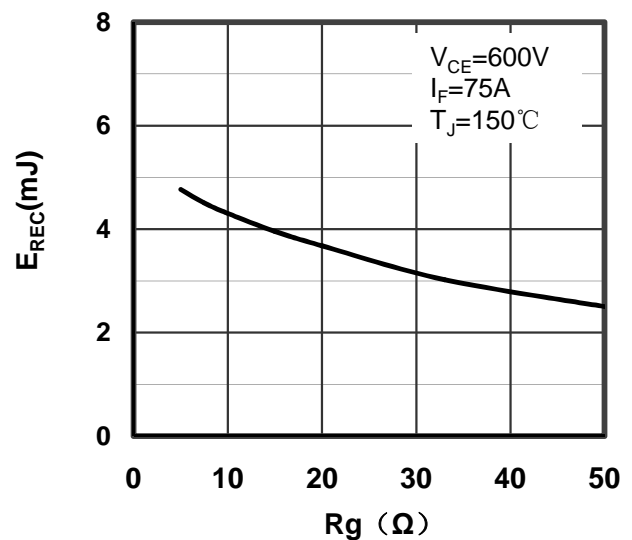

Figure 8. Switching Energy vs Gate Resistor Diode-inverter

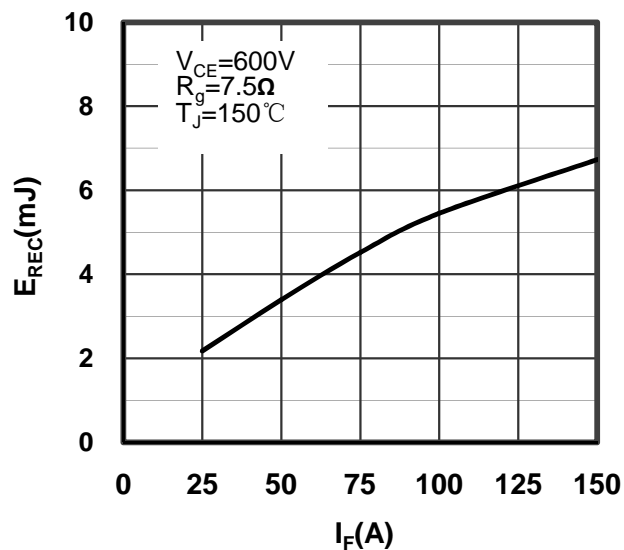

Figure 9. Switching Energy vs Forward Current Diode-inverter

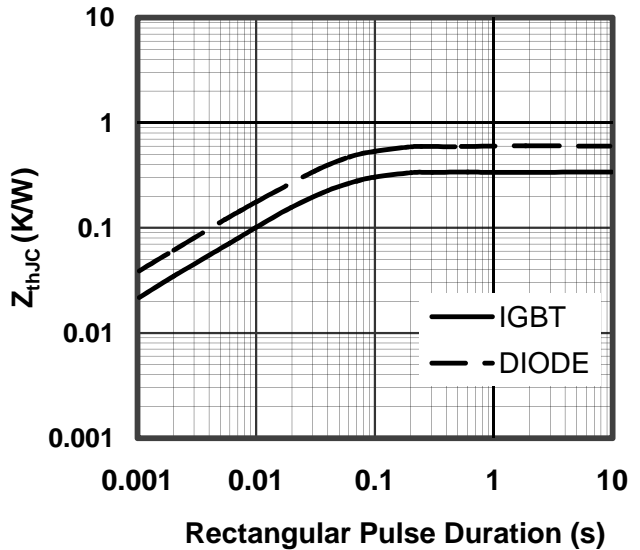

Figure 10. Transient Thermal Impedance of Diode and IGBT-inverter

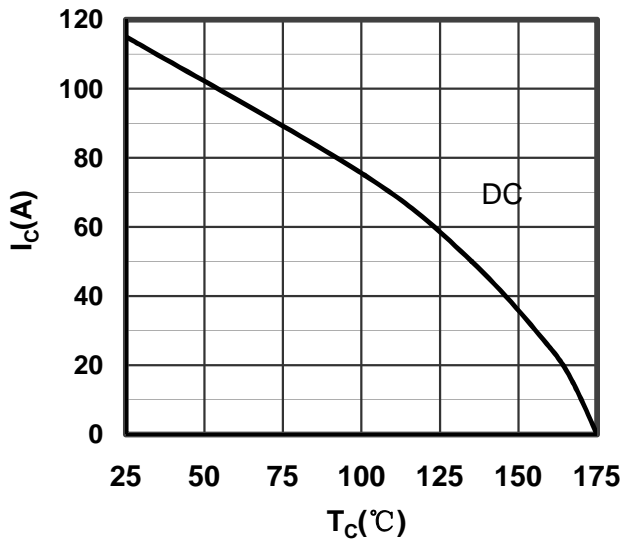

Figure 11. Collector Current vs Case temperature IGBT -inverter

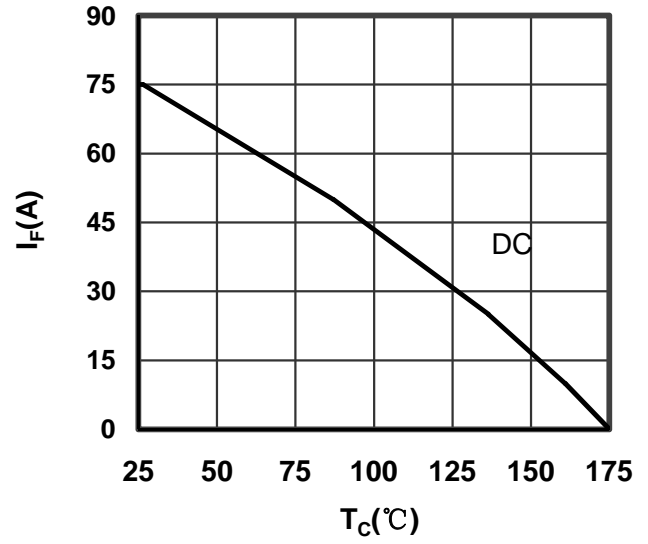

Figure 12. Forward current vs Case temperature Diode -inverter

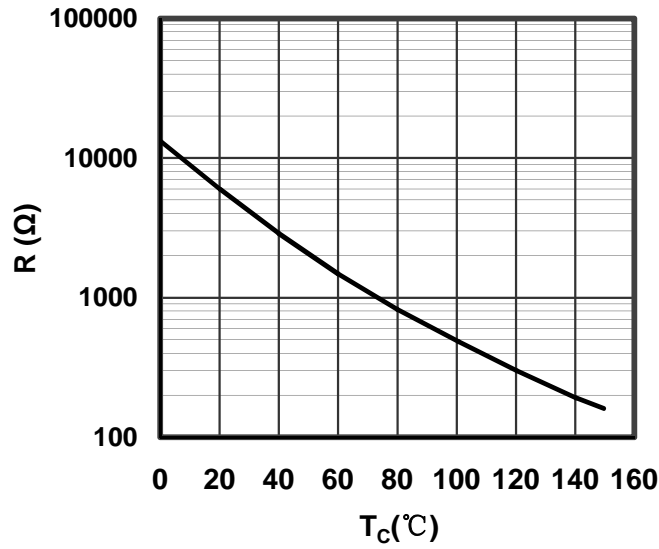

Figure 13. NTC Characteristics

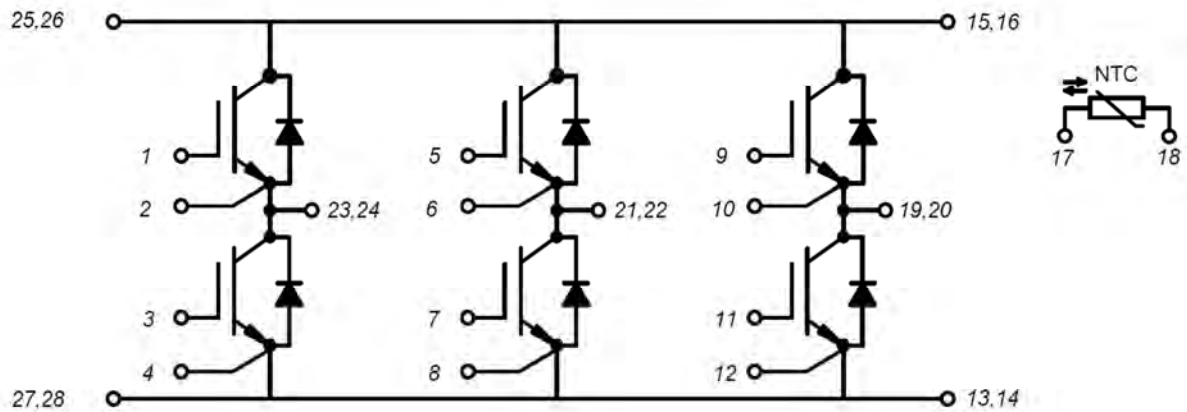
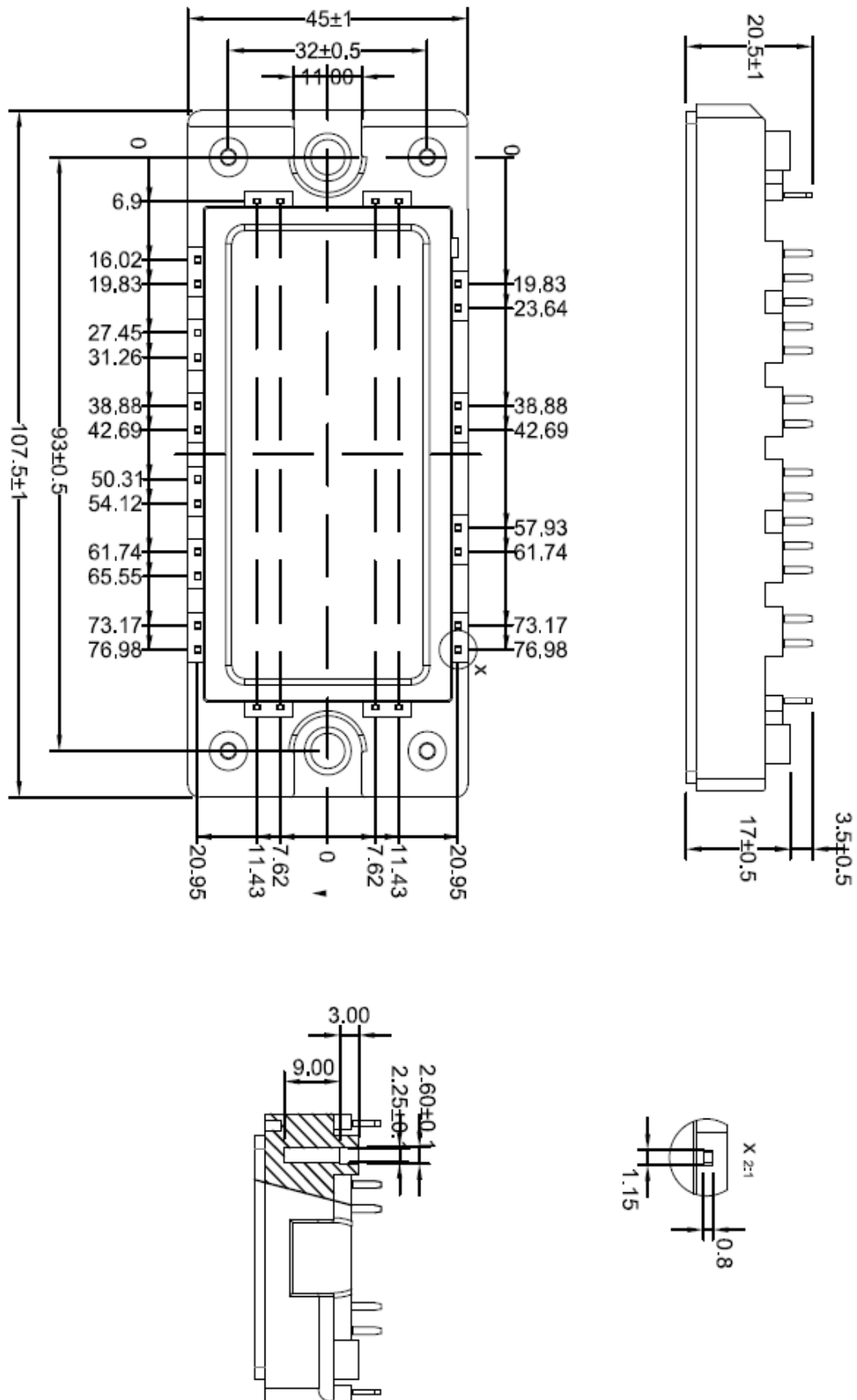

Figure 14. Circuit Diagram



Dimensions in (mm)
Figure 15. Package Outline