

## PRODUCT FEATURES

- IGBT<sup>3</sup> CHIP(Trench+Field Stop technology)
- High short circuit capability,self limiting short circuit current
- $V_{CE(sat)}$  with positive temperature coefficient
- Fast switching and short tail current
- Free wheeling diodes with fast and soft reverse recovery
- Low switching losses

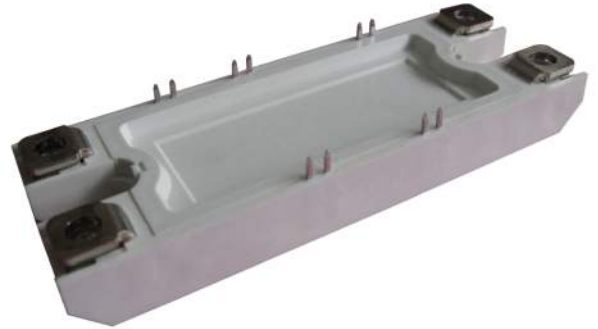

## APPLICATIONS

- High frequency switching application
- Medical applications
- Motion/servo control
- UPS systems

## IGBT-inverter

### ABSOLUTE MAXIMUM RATINGS( $T_C=25^\circ\text{C}$ unless otherwise specified)

| Symbol    | Parameter/Test Conditions         |                        | Values   | Unit |
|-----------|-----------------------------------|------------------------|----------|------|
| $V_{CES}$ | Collector Emitter Voltage         | $T_J=25^\circ\text{C}$ | 600      | V    |
| $V_{GES}$ | Gate Emitter Voltage              |                        | $\pm 20$ |      |
| $I_C$     | DC Collector Current              | $T_C=25^\circ\text{C}$ | 95       | A    |
|           |                                   | $T_C=70^\circ\text{C}$ | 75       |      |
| $I_{CM}$  | Repetitive Peak Collector Current | $tp=1\text{ms}$        | 150      |      |
| $P_{tot}$ | Power Dissipation Per IGBT        |                        | 250      | W    |

## Diode-inverter

### ABSOLUTE MAXIMUM RATINGS ( $T_C=25^\circ\text{C}$ unless otherwise specified)

| Symbol      | Parameter/Test Conditions       |   | Values | Unit                 |
|-------------|---------------------------------|---|--------|----------------------|
| $V_{RRM}$   | Repetitive Reverse Voltage      | $T_J=25^\circ\text{C}$                                | 600    | V                    |
| $I_{F(AV)}$ | Average Forward Current         | $T_C=25^\circ\text{C}$                                | 75     | A                    |
| $I_{FRM}$   | Repetitive Peak Forward Current | $tp=1\text{ms}$                                       | 150    |                      |
| $I^2t$      |                                 | $T_J=125^\circ\text{C}, t=10\text{ms}, V_R=0\text{V}$ | 660    | $\text{A}^2\text{S}$ |

## IGBT-inverter

ELECTRICAL CHARACTERISTICS ( $T_C=25^\circ\text{C}$  unless otherwise specified)

| Symbol        | Parameter/Test Conditions                        |  | Min.                    | Typ. | Max. | Unit          |    |
|---------------|--|--|-------------------------|------|------|---------------|----|
| $V_{GE(th)}$  | Gate Emitter Threshold Voltage                   | $V_{CE}=V_{GE}, I_C=1.2\text{mA}$  | 4.9                     | 5.8  | 6.5  | V             |    |
| $V_{CE(sat)}$ | Collector Emitter Saturation Voltage             | $I_C=75\text{A}, V_{GE}=15\text{V}, T_J=25^\circ\text{C}$  |                         | 1.45 | 1.9  |               |    |
|               |  | $I_C=75\text{A}, V_{GE}=15\text{V}, T_J=125^\circ\text{C}$   |                         | 1.6  |      |               |    |
| $I_{CES}$     | Collector Leakage Current                        | $V_{CE}=600\text{V}, V_{GE}=0\text{V}, T_J=25^\circ\text{C}$   |                         |      | 1    | mA            |    |
|               |  | $V_{CE}=600\text{V}, V_{GE}=0\text{V}, T_J=125^\circ\text{C}$  |                         |      | 5    | mA            |    |
| $I_{GES}$     | Gate Leakage Current                             | $V_{CE}=0\text{V}, V_{GE}=\pm 15\text{V}, T_J=25^\circ\text{C}$  | -400                    |      | 400  | nA            |    |
| $R_{gint}$    | Integrated Gate Resistor                         |  |                         | 0    |      | $\Omega$      |    |
| $Q_g$         | Gate Charge                                      | $V_{CE}=300\text{V}, I_C=75\text{A}, V_{GE}=\pm 15\text{V}$  |                         | 0.8  |      | $\mu\text{C}$ |    |
| $C_{ies}$     | Input Capacitance                                | $V_{CE}=25\text{V}, V_{GE}=0\text{V}, f=1\text{MHz}$   |                         | 4.6  |      | nF            |    |
| $C_{res}$     | Reverse Transfer Capacitance                     |  |                         |      | 145  |               | pF |
| $t_{d(on)}$   | Turn on Delay Time                               | $V_{CC}=300\text{V}, I_C=75\text{A}$<br>$R_G=5.1\Omega,$<br>$V_{GE}=\pm 15\text{V},$<br>Inductive Load | $T_J=25^\circ\text{C}$  |      | 25   |               | ns |
|               |  |  | $T_J=125^\circ\text{C}$ |      | 25   |               | ns |
| $t_r$         | Rise Time  |  | $T_J=25^\circ\text{C}$  |      | 20   |               | ns |
|               |  |  | $T_J=125^\circ\text{C}$ |      | 20   |               | ns |
| $t_{d(off)}$  | Turn off Delay Time                              | $V_{CC}=300\text{V}, I_C=75\text{A}$<br>$R_G=5.1\Omega,$<br>$V_{GE}=\pm 15\text{V},$<br>Inductive Load | $T_J=25^\circ\text{C}$  |      | 210  |               | ns |
|               |  |  | $T_J=125^\circ\text{C}$ |      | 240  |               | ns |
| $t_f$         | Fall Time  |  | $T_J=25^\circ\text{C}$  |      | 60   |               | ns |
|               |  |  | $T_J=125^\circ\text{C}$ |      | 70   |               | ns |
| $E_{on}$      | Turn on Energy                                   | $V_{CC}=300\text{V}, I_C=75\text{A}$<br>$R_G=5.1\Omega,$<br>$V_{GE}=\pm 15\text{V},$<br>Inductive Load | $T_J=25^\circ\text{C}$  |      | 0.35 |               | mJ |
|               |  |  | $T_J=125^\circ\text{C}$ |      | 0.5  |               | mJ |
| $E_{off}$     | Turn off Energy                                  |  | $T_J=25^\circ\text{C}$  |      | 2.4  |               | mJ |
|               |  |  | $T_J=125^\circ\text{C}$ |      | 2.8  |               | mJ |
| $I_{sc}$      | Short Circuit Current                            | $t_{psc}\leq 6\mu\text{s}, V_{GE}=15\text{V}$<br>$T_J=125^\circ\text{C}, V_{CC}=360\text{V}$           |                         | 380  |      | A             |    |
| $R_{thJC}$    | Junction to Case Thermal Resistance ( Per IGBT ) |  |                         |      | 0.6  | K/W           |    |

## Diode-inverter

ELECTRICAL CHARACTERISTICS ( $T_C=25^\circ\text{C}$  unless otherwise specified)

| Symbol      | Parameter/Test Conditions                         |   | Min. | Typ. | Max. | Unit          |
|-------------|---|---|------|------|------|---------------|
| $V_F$       | Forward Voltage                                   | $I_F=75\text{A}, V_{GE}=0\text{V}, T_J=25^\circ\text{C}$  |      | 1.55 | 1.95 | V             |
|             |   | $I_F=75\text{A}, V_{GE}=0\text{V}, T_J=125^\circ\text{C}$ |      | 1.50 |      |               |
| $t_{rr}$    | Reverse Recovery Time                             | $I_F=75\text{A}, V_R=300\text{V}$                         |      | 120  |      | ns            |
| $I_{RRM}$   | Max. Reverse Recovery Current                     | $di_F/dt=-4000\text{A}/\mu\text{s}$                       |      | 115  |      | A             |
| $Q_{RR}$    | Reverse Recovery Charge                           | $T_J=125^\circ\text{C}$                                   |      | 6    |      | $\mu\text{C}$ |
| $E_{rec}$   | Reverse Recovery Energy                           |   |      | 1.5  |      | mJ            |
| $R_{thJCD}$ | Junction to Case Thermal Resistance ( Per Diode ) |   |      |      | 0.95 | K/W           |

**NTC CHARACTERISTICS** ( $T_C=25^\circ\text{C}$  unless otherwise specified)

| Symbol      | Parameter/Test Conditions                                     |                        | Min. | Typ. | Max. | Unit       |
|-------------|---|------------------------|------|------|------|------------|
| $R_{25}$    | Resistance  | $T_C=25^\circ\text{C}$ |      | 5    |      | K $\Omega$ |
| $B_{25/50}$ | $R_2 = R_{25} \exp [B_{25/50}(1/T_2 - 1/(298.15 \text{ K}))]$ |                        |      | 3375 |      | K          |

**MODULE CHARACTERISTICS** ( $T_C=25^\circ\text{C}$  unless otherwise specified)

| Symbol     | Parameter/Test Conditions   |                  | Values                     | Unit |
|------------|-----------------------------|------------------|----------------------------|------|
| $T_{Jmax}$ | Max. Junction Temperature   |                  | 175                        | °C   |
| $T_{Jop}$  | Operating Temperature       |                  | -40~150                    |      |
| $T_{stg}$  | Storage Temperature         |                  | -40~125                    |      |
| $V_{isol}$ | Isolation Breakdown Voltage |                  | AC, 50Hz(R.M.S), t=1minute | V    |
| Torque     | to heatsink                 | Recommended (M6) | 3~5                        | Nm   |
|            | to terminal                 | Recommended (M5) | 2.5~5                      | Nm   |
| Weight     |                             |                  | 200                        | g    |

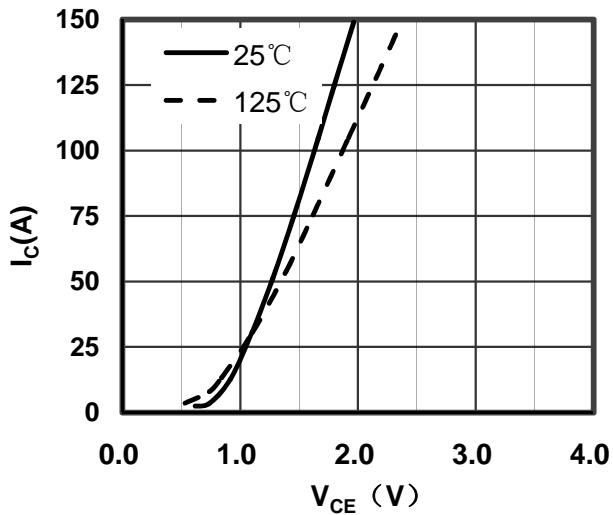

Figure 1. Typical Output Characteristics IGBT-inverter

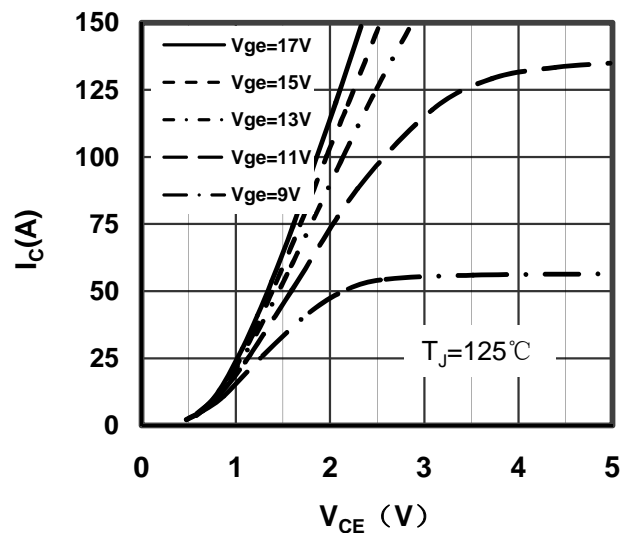

Figure 2. Typical Output Characteristics IGBT-inverter

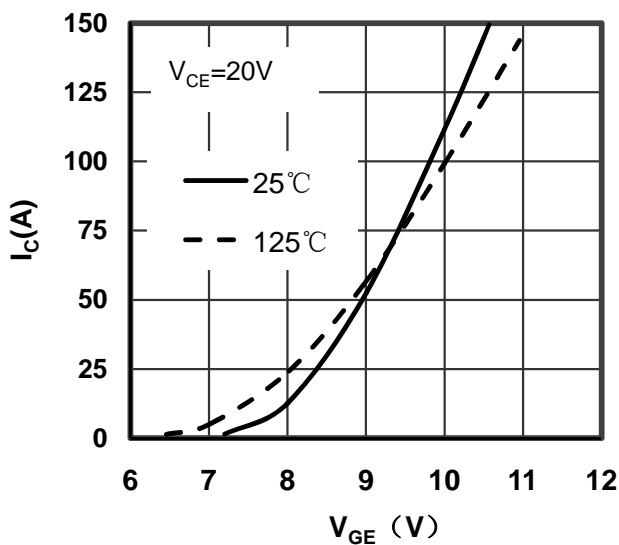

Figure 3. Typical Transfer Characteristics IGBT-inverter

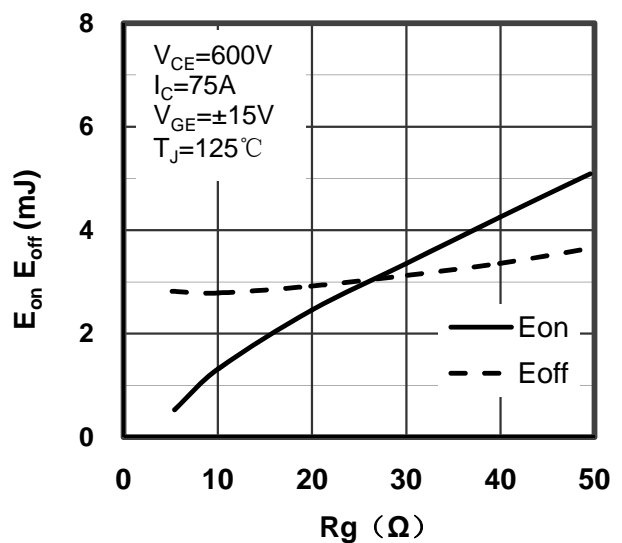

Figure 4. Switching Energy vs Gate Resistor IGBT-inverter

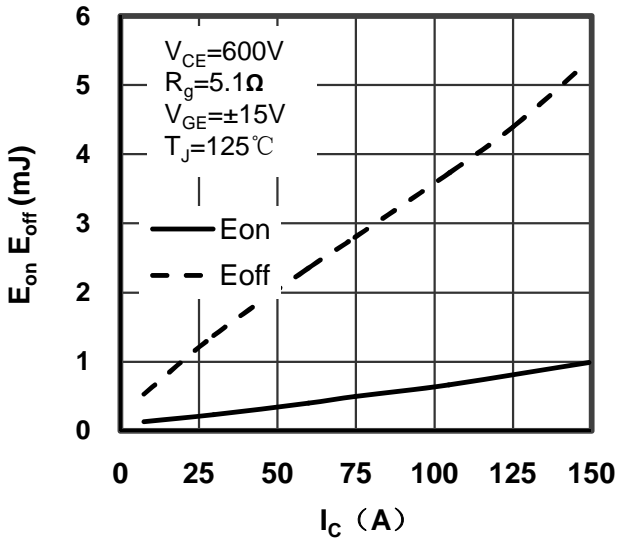

Figure 5. Switching Energy vs Collector Current IGBT-inverter

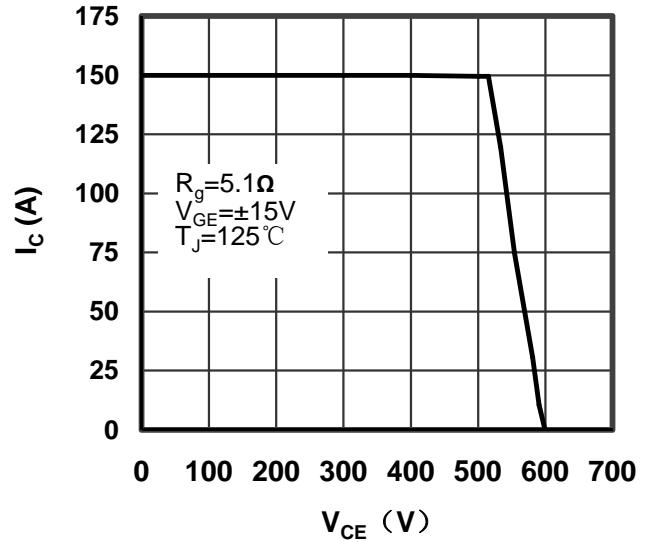

Figure 6. Reverse Biased Safe Operating Area IGBT-inverter

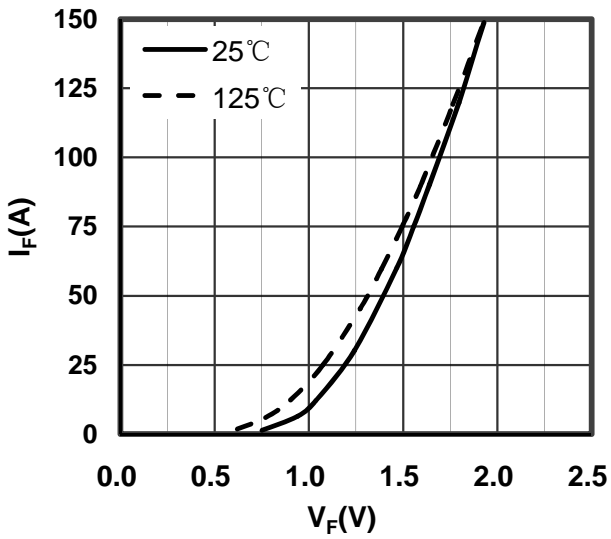

Figure 7. Diode Forward Characteristics Diode-inverter

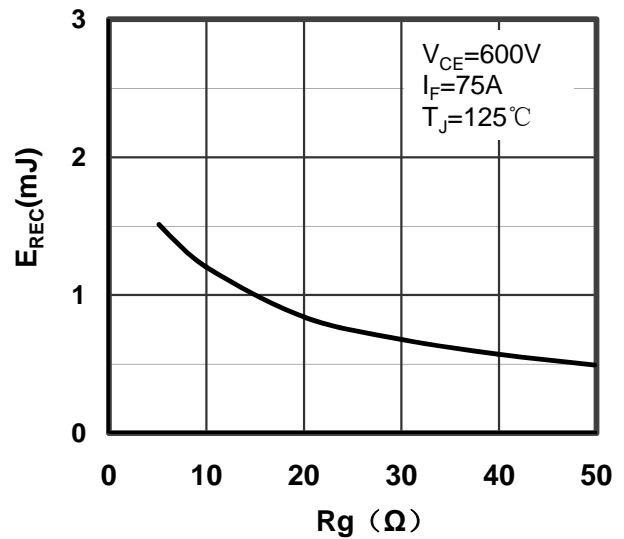

Figure 8. Switching Energy vs Gate Resistor Diode-inverter

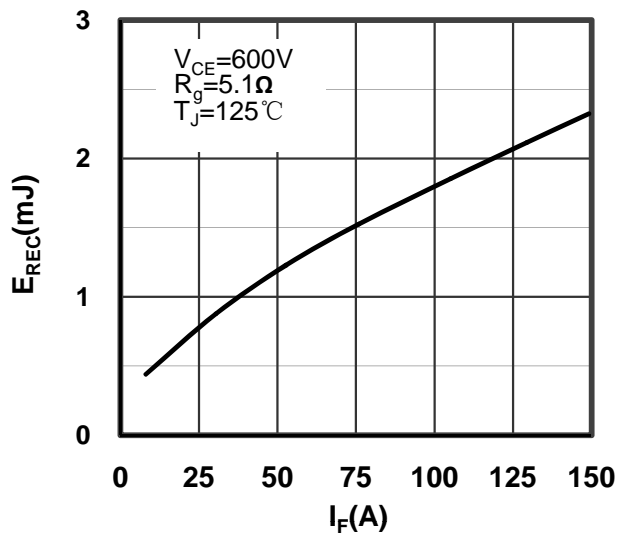

Figure 9. Switching Energy vs Forward Current Diode-inverter

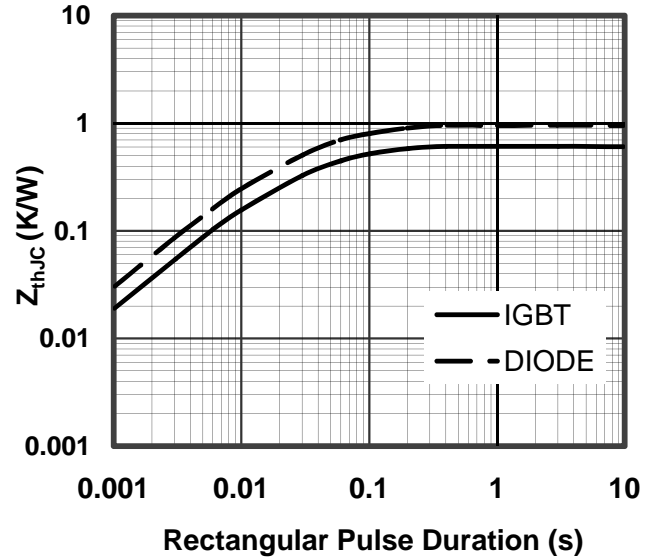

Figure 10. Transient Thermal Impedance of Diode and IGBT-inverter

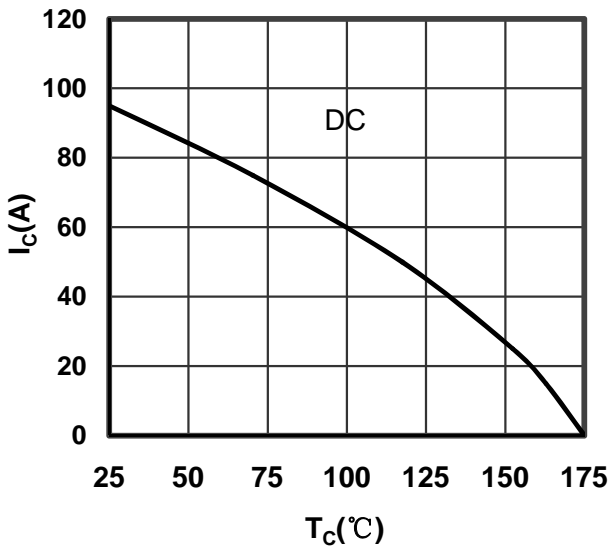

Figure 11. Collector Current vs Case temperature IGBT -inverter

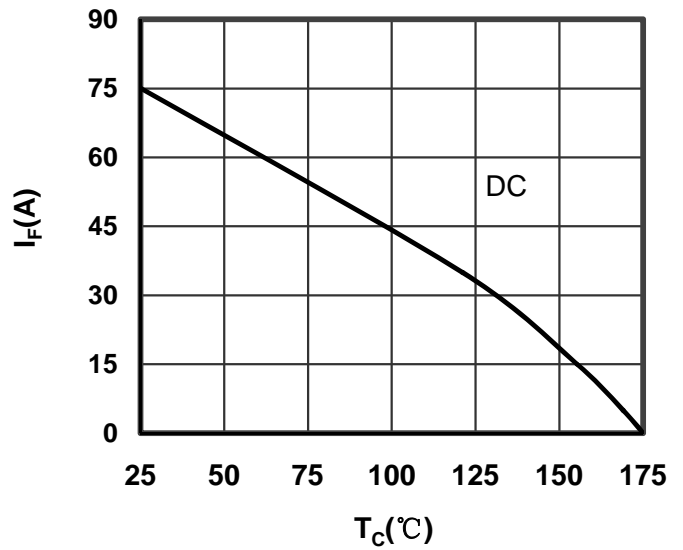

Figure 12. Forward current vs Case temperature Diode -inverter

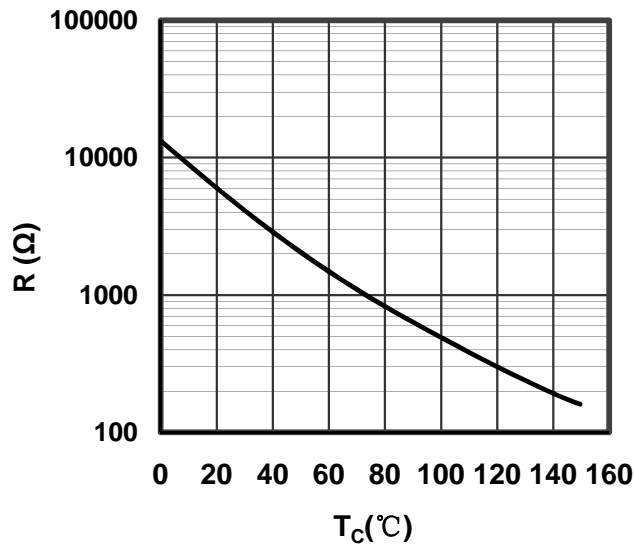

Figure 13. NTC Characteristics

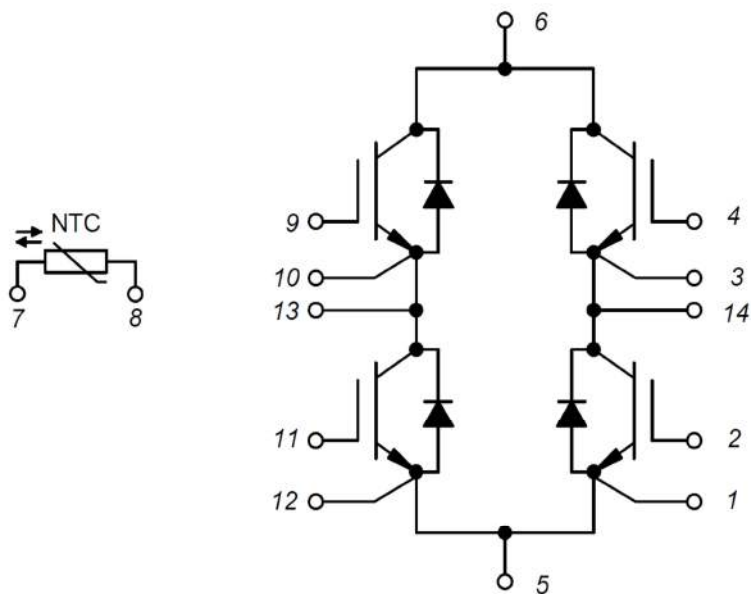
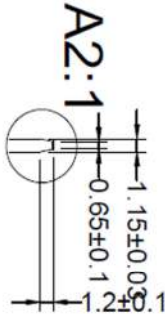
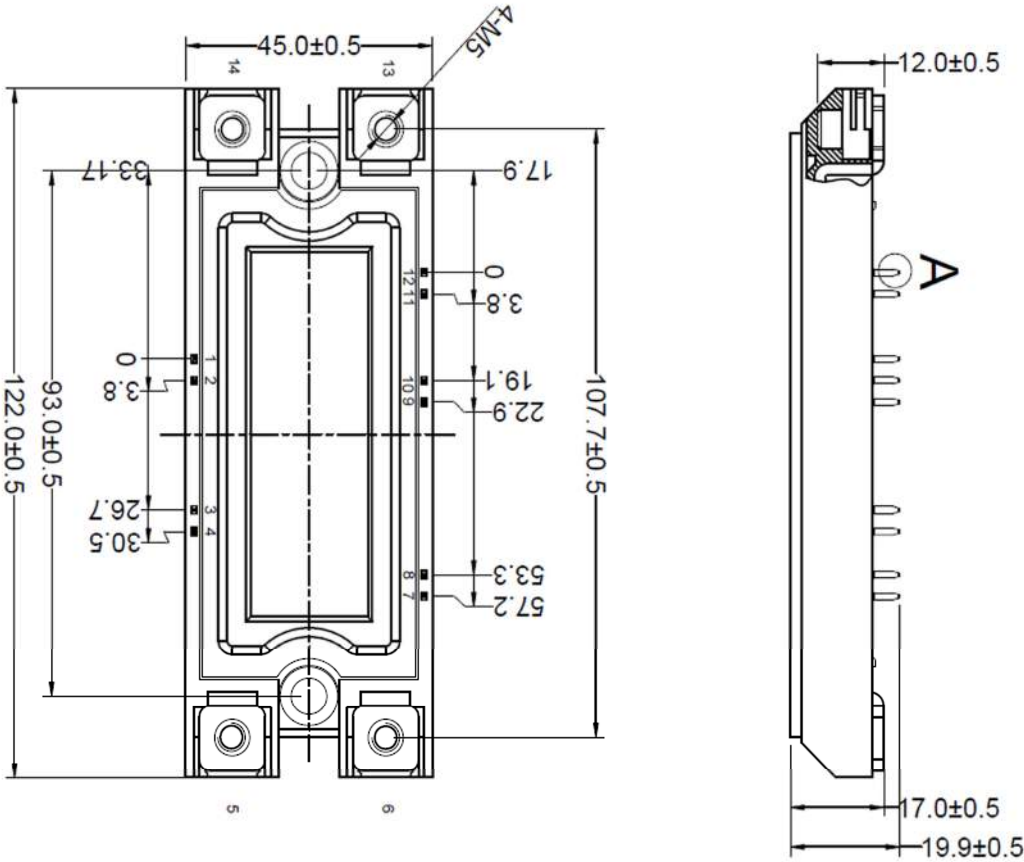

Figure 14. Circuit Diagram



Dimensions in (mm)  
Figure 15. Package Outline