

PRODUCT FEATURES

- High level of integration
- 600V IGBT³ CHIP(Trench+Field Stop technology)
- Low saturation voltage and positive temperature coefficient
- Fast switching and short tail current
- Free wheeling diodes with fast and soft reverse recovery
- Industry standard package with insulated copper base plate and soldering pins for PCB mounting
- Temperature sense included

APPLICATIONS

- AC motor control
- Motion/servo control
- Inverter and power supplies

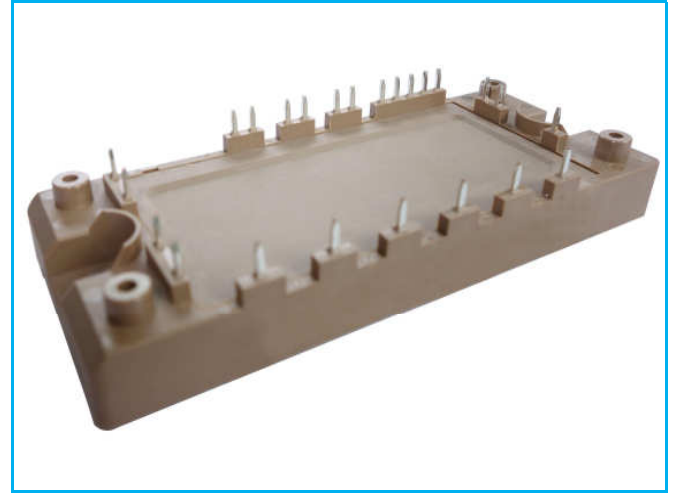

Rectifier+Brake+Inverter

IGBT-inverter

ABSOLUTE MAXIMUM RATINGS($T_C=25^{\circ}\text{C}$ unless otherwise specified)

| Symbol | Parameter/Test Conditions | | Values | Unit |
|-----------|-----------------------------------|--------------------------------------------------------|----------|------|
| V_{CES} | Collector Emitter Voltage | $T_J=25^{\circ}\text{C}$ | 600 | V |
| V_{GES} | Gate Emitter Voltage | | ± 20 | |
| I_C | DC Collector Current | $T_C=25^{\circ}\text{C}, T_{Jmax}=175^{\circ}\text{C}$ | 95 | A |
| | | $T_C=75^{\circ}\text{C}, T_{Jmax}=175^{\circ}\text{C}$ | 75 | |
| I_{CM} | Repetitive Peak Collector Current | $t_p=1\text{ms}$ | 150 | |
| P_{tot} | Power Dissipation Per IGBT | $T_C=25^{\circ}\text{C}, T_{Jmax}=175^{\circ}\text{C}$ | 250 | W |

Diode-inverter

ABSOLUTE MAXIMUM RATINGS ($T_C=25^{\circ}\text{C}$ unless otherwise specified)

| Symbol | Parameter/Test Conditions | | Values | Unit |
|-------------|---------------------------------|---------------------------------------------------------|--------|------------------|
| V_{RRM} | Repetitive Reverse Voltage | $T_J=25^{\circ}\text{C}$ | 600 | V |
| $I_{F(AV)}$ | Average Forward Current | | 75 | A |
| I_{FRM} | Repetitive Peak Forward Current | $t_p=1\text{ms}$ | 150 | |
| I^2t | | $T_J=125^{\circ}\text{C}, t=10\text{ms}, V_R=0\text{V}$ | 660 | A ² S |

MacMic Science & Technology Co., Ltd.

Add: #18, Hua Shan Zhong Lu, New District, Changzhou City, Jiangsu Province, P. R. of China

Tel.: +86-519-85163708 Fax: +86-519-85162291 Post Code: 213022 Website: www.macmicst.com

MMG75H060XB6EN

IGBT-inverter

ELECTRICAL CHARACTERISTICS ($T_C=25^\circ\text{C}$ unless otherwise specified)

| Symbol | Parameter/Test Conditions | | Min. | Typ. | Max. | Unit |
|---------------|------------------------------------------------|-------------------------------------------------------------------------------------------------------|-------------------------|------|------|---------------|
| $V_{GE(th)}$ | Gate Emitter Threshold Voltage | $V_{CE}=V_{GE}, I_C=1.2\text{mA}$ | 4.9 | 5.8 | 6.5 | V |
| $V_{CE(sat)}$ | Collector Emitter Saturation Voltage | $I_C=75\text{A}, V_{GE}=15\text{V}, T_J=25^\circ\text{C}$ | | 1.45 | 1.9 | |
| | | $I_C=75\text{A}, V_{GE}=15\text{V}, T_J=125^\circ\text{C}$ | | 1.6 | | |
| | | $I_C=75\text{A}, V_{GE}=15\text{V}, T_J=150^\circ\text{C}$ | | 1.7 | | |
| I_{CES} | Collector Leakage Current | $V_{CE}=600\text{V}, V_{GE}=0\text{V}, T_J=25^\circ\text{C}$ | | | 1 | mA |
| | | $V_{CE}=600\text{V}, V_{GE}=0\text{V}, T_J=150^\circ\text{C}$ | | | 10 | mA |
| I_{GES} | Gate Leakage Current | $V_{CE}=0\text{V}, V_{GE}=\pm 20\text{V}, T_J=25^\circ\text{C}$ | -400 | | 400 | nA |
| R_{gint} | Integrated Gate Resistor | | | 0 | | Ω |
| Q_g | Gate Charge | $V_{CE}=300\text{V}, I_C=75\text{A}, V_{GE}=\pm 15\text{V}$ | | 0.8 | | μC |
| C_{ies} | Input Capacitance | $V_{CE}=25\text{V}, V_{GE}=0\text{V}, f=1\text{MHz}$ | | 4.6 | | nF |
| C_{res} | Reverse Transfer Capacitance | | | | 145 | |
| $t_{d(on)}$ | Turn on Delay Time | $V_{CC}=300\text{V}, I_C=75\text{A}$ $R_G=30\Omega,$ $V_{GE}=\pm 15\text{V},$ Inductive Load | $T_J=25^\circ\text{C}$ | | 100 | ns |
| | | | $T_J=150^\circ\text{C}$ | | 100 | ns |
| t_r | Rise Time | $V_{GE}=\pm 15\text{V},$ Inductive Load | $T_J=25^\circ\text{C}$ | | 60 | ns |
| | | | $T_J=150^\circ\text{C}$ | | 70 | ns |
| $t_{d(off)}$ | Turn off Delay Time | $V_{CC}=300\text{V}, I_C=75\text{A}$ $R_G=30\Omega,$ $V_{GE}=\pm 15\text{V},$ Inductive Load | $T_J=25^\circ\text{C}$ | | 600 | ns |
| | | | $T_J=150^\circ\text{C}$ | | 700 | ns |
| t_f | Fall Time | $V_{GE}=\pm 15\text{V},$ Inductive Load | $T_J=25^\circ\text{C}$ | | 40 | ns |
| | | | $T_J=150^\circ\text{C}$ | | 60 | ns |
| E_{on} | Turn on Energy | $V_{CC}=300\text{V}, I_C=75\text{A}$ $R_G=30\Omega,$ $V_{GE}=\pm 15\text{V},$ Inductive Load | $T_J=25^\circ\text{C}$ | | 3.5 | mJ |
| | | | $T_J=125^\circ\text{C}$ | | 4.1 | mJ |
| | | | $T_J=150^\circ\text{C}$ | | 4.5 | mJ |
| E_{off} | Turn off Energy | $V_{GE}=\pm 15\text{V},$ Inductive Load | $T_J=25^\circ\text{C}$ | | 2.9 | mJ |
| | | | $T_J=125^\circ\text{C}$ | | 3.6 | mJ |
| | | | $T_J=150^\circ\text{C}$ | | 3.8 | mJ |
| I_{SC} | Short Circuit Current | $tp_{sc}\leq 6\mu\text{s}, V_{GE}=15\text{V}$ $T_J=150^\circ\text{C}, V_{CC}=360\text{V}$ | | 380 | | A |
| R_{thJC} | Junction to Case Thermal Resistance (Per IGBT) | | | | 0.6 | K/W |

Diode-inverter

ELECTRICAL CHARACTERISTICS ($T_C=25^\circ\text{C}$ unless otherwise specified)

| Symbol | Parameter/Test Conditions | | Min. | Typ. | Max. | Unit |
|-------------|-------------------------------------------------|-----------------------------------------------------------|------|------|------|---------------|
| V_F | Forward Voltage | $I_F=75\text{A}, V_{GE}=0\text{V}, T_J=25^\circ\text{C}$ | | 1.55 | 1.95 | V |
| | | $I_F=75\text{A}, V_{GE}=0\text{V}, T_J=125^\circ\text{C}$ | | 1.50 | | |
| | | $I_F=75\text{A}, V_{GE}=0\text{V}, T_J=150^\circ\text{C}$ | | 1.45 | | |
| I_{RRM} | Max. Reverse Recovery Current | $I_F=75\text{A}, V_R=300\text{V}$ | | 51 | | A |
| Q_{RR} | Reverse Recovery Charge | $di_F/dt=-1200\text{A}/\mu\text{s}$ | | 5.6 | | μC |
| E_{rec} | Reverse Recovery Energy | $T_J=150^\circ\text{C}$ | | 1 | | mJ |
| R_{thJCD} | Junction to Case Thermal Resistance (Per Diode) | | | | 0.95 | K/W |

MMG75H060XB6EN

Diode-RECTIFIER

ABSOLUTE MAXIMUM RATINGS ($T_C=25^\circ\text{C}$ unless otherwise specified)

| Symbol | Parameter/Test Conditions | | Values | Unit |
|------------|--------------------------------------|--------------------------------------------------|--------|------------------|
| V_{RRM} | Repetitive Reverse Voltage | $T_J=25^\circ\text{C}$ | 1600 | V |
| I_{FRMS} | R.M.S. Forward Current Per Diode | $T_C=80^\circ\text{C}$ | 75 | |
| I_{RMS} | R.M.S. Current at rectifier output | | 80 | |
| I_{FSM} | Non Repetitive Surge Forward Current | $T_J=45^\circ\text{C}$, $t=10\text{ms}$, 50Hz | 480 | |
| | | $T_J=45^\circ\text{C}$, $t=8.3\text{ms}$, 60Hz | 527 | |
| I^2t | | $T_J=45^\circ\text{C}$, $t=10\text{ms}$, 50Hz | 1152 | A ² S |
| | | $T_J=45^\circ\text{C}$, $t=8.3\text{ms}$, 60Hz | 1152 | |

Diode-RECTIFIER

ELECTRICAL CHARACTERISTICS ($T_C=25^\circ\text{C}$ unless otherwise specified)

| Symbol | Parameter/Test Conditions | | Min. | Typ. | Max. | Unit |
|-------------|--------------------------------------------------|----------------------------------------------|------|------|------|---------------|
| V_F | Forward Voltage | $I_F=75\text{A}$, $T_J=25^\circ\text{C}$ | | 1.2 | 1.35 | V |
| | | $I_F=75\text{A}$, $T_J=150^\circ\text{C}$ | | 1.2 | | V |
| I_R | Reverse Leakage Current | $V_R=1600\text{V}$, $T_J=25^\circ\text{C}$ | | | 50 | μA |
| | | $V_R=1600\text{V}$, $T_J=150^\circ\text{C}$ | | | 1 | mA |
| R_{thJCD} | Junction to Case Thermal Resistance (Per Diode) | | | | 0.8 | K /W |

IGBT-Brake chopper

ABSOLUTE MAXIMUM RATINGS ($T_C=25^\circ\text{C}$ unless otherwise specified)

| Symbol | Parameter/Test Conditions | | Values | Unit |
|-----------|-----------------------------------|-------------------------------------------------------|----------|------|
| V_{CES} | Collector Emitter Voltage | $T_J=25^\circ\text{C}$ | 600 | V |
| V_{GES} | Gate Emitter Voltage | | ± 20 | |
| I_C | DC Collector Current | $T_C=25^\circ\text{C}$, $T_{Jmax}=175^\circ\text{C}$ | 36 | A |
| | | $T_C=60^\circ\text{C}$, $T_{Jmax}=175^\circ\text{C}$ | 30 | |
| I_{CM} | Repetitive Peak Collector Current | $t_p=1\text{ms}$ | 60 | |
| P_{tot} | Power Dissipation Per IGBT | $T_C=25^\circ\text{C}$, $T_{Jmax}=175^\circ\text{C}$ | 111 | W |

Diode-Brake chopper

ABSOLUTE MAXIMUM RATINGS ($T_C=25^\circ\text{C}$ unless otherwise specified)

| Symbol | Parameter/Test Conditions | | Values | Unit |
|-------------|---------------------------------|-------------------------------------------------------------|--------|------------------|
| V_{RRM} | Repetitive Reverse Voltage | $T_J=25^\circ\text{C}$ | 600 | V |
| $I_{F(AV)}$ | Average Forward Current | | 20 | A |
| I_{FRM} | Repetitive Peak Forward Current | $t_p=1\text{ms}$ | 40 | |
| I^2t | | $T_J=125^\circ\text{C}$, $t=10\text{ms}$, $V_R=0\text{V}$ | 49 | A ² S |

MMG75H060XB6EN

IGBT-Brake chopper

ELECTRICAL CHARACTERISTICS ($T_C=25^\circ\text{C}$ unless otherwise specified)

| Symbol | Parameter/Test Conditions | | Min. | Typ. | Max. | Unit |
|---------------|------------------------------------------------|-------------------------------------------------------------------------------------------------------|-------------------------|------|------|----------|
| $V_{GE(th)}$ | Gate Emitter Threshold Voltage | $V_{CE}=V_{GE}, I_C=0.43\text{mA}$ | 4.2 | 5.1 | 5.7 | V |
| $V_{CE(sat)}$ | Collector Emitter Saturation Voltage | $I_C=30\text{A}, V_{GE}=15\text{V}, T_J=25^\circ\text{C}$ | | 1.95 | 2.4 | |
| | | $I_C=30\text{A}, V_{GE}=15\text{V}, T_J=125^\circ\text{C}$ | | 2.2 | | |
| | | $I_C=30\text{A}, V_{GE}=15\text{V}, T_J=150^\circ\text{C}$ | | 2.3 | | |
| I_{CES} | Collector Leakage Current | $V_{CE}=600\text{V}, V_{GE}=0\text{V}, T_J=25^\circ\text{C}$ | | | 1 | mA |
| | | $V_{CE}=600\text{V}, V_{GE}=0\text{V}, T_J=150^\circ\text{C}$ | | | 10 | mA |
| I_{GES} | Gate Leakage Current | $V_{CE}=0\text{V}, V_{GE}=\pm 20\text{V}, T_J=25^\circ\text{C}$ | -400 | | 400 | nA |
| R_{gint} | Integrated Gate Resistor | | | 0 | | Ω |
| Q_g | Gate Charge | $V_{CE}=480\text{V}, I_C=30\text{A}, V_{GE}=\pm 15\text{V}$ | | 165 | | nC |
| C_{ies} | Input Capacitance | $V_{CE}=25\text{V}, V_{GE}=0\text{V}, f=1\text{MHz}$ | | 1.9 | | nF |
| C_{res} | Reverse Transfer Capacitance | | | | 55 | |
| $t_{d(on)}$ | Turn on Delay Time | $V_{CC}=300\text{V}, I_C=30\text{A}$ $R_G=30\Omega,$ $V_{GE}=\pm 15\text{V},$ Inductive Load | $T_J=25^\circ\text{C}$ | | 25 | ns |
| | | | $T_J=150^\circ\text{C}$ | | 30 | ns |
| t_r | Rise Time | $V_{GE}=\pm 15\text{V},$ Inductive Load | $T_J=25^\circ\text{C}$ | | 45 | ns |
| | | | $T_J=150^\circ\text{C}$ | | 50 | ns |
| $t_{d(off)}$ | Turn off Delay Time | $V_{CC}=300\text{V}, I_C=30\text{A}$ $R_G=30\Omega,$ $V_{GE}=\pm 15\text{V},$ Inductive Load | $T_J=25^\circ\text{C}$ | | 220 | ns |
| | | | $T_J=150^\circ\text{C}$ | | 250 | ns |
| t_f | Fall Time | $V_{GE}=\pm 15\text{V},$ Inductive Load | $T_J=25^\circ\text{C}$ | | 35 | ns |
| | | | $T_J=150^\circ\text{C}$ | | 40 | ns |
| E_{on} | Turn on Energy | $V_{CC}=300\text{V}, I_C=30\text{A}$ $R_G=30\Omega,$ $V_{GE}=\pm 15\text{V},$ Inductive Load | $T_J=25^\circ\text{C}$ | | 0.72 | mJ |
| | | | $T_J=125^\circ\text{C}$ | | 0.9 | mJ |
| | | | $T_J=150^\circ\text{C}$ | | 0.94 | mJ |
| E_{off} | Turn off Energy | $V_{GE}=\pm 15\text{V},$ Inductive Load | $T_J=25^\circ\text{C}$ | | 0.25 | mJ |
| | | | $T_J=125^\circ\text{C}$ | | 0.34 | mJ |
| | | | $T_J=150^\circ\text{C}$ | | 0.36 | mJ |
| I_{SC} | Short Circuit Current | $tp_{sc} \leq 5\mu\text{s}, V_{GE}=15\text{V}$ $T_J=150^\circ\text{C}, V_{CC}=360\text{V}$ | | 160 | | A |
| R_{thJC} | Junction to Case Thermal Resistance (Per IGBT) | | | | 1.35 | K/W |

Diode-inverter

ELECTRICAL CHARACTERISTICS ($T_C=25^\circ\text{C}$ unless otherwise specified)

| Symbol | Parameter/Test Conditions | | Min. | Typ. | Max. | Unit |
|-------------|-------------------------------------------------|-----------------------------------------------------------|------|------|------|---------------|
| V_F | Forward Voltage | $I_F=20\text{A}, V_{GE}=0\text{V}, T_J=25^\circ\text{C}$ | | 1.60 | 2.0 | V |
| | | $I_F=20\text{A}, V_{GE}=0\text{V}, T_J=125^\circ\text{C}$ | | 1.55 | | |
| | | $I_F=20\text{A}, V_{GE}=0\text{V}, T_J=150^\circ\text{C}$ | | 1.50 | | |
| I_{RRM} | Max. Reverse Recovery Current | $I_F=20\text{A}, V_R=300\text{V}$ | | 20 | | A |
| Q_{RR} | Reverse Recovery Charge | $di_F/dt=-700\text{A}/\mu\text{s}$ | | 1.8 | | μC |
| E_{rec} | Reverse Recovery Energy | $T_J=150^\circ\text{C}$ | | 0.4 | | mJ |
| R_{thJCD} | Junction to Case Thermal Resistance (Per Diode) | | | | 2.5 | K/W |

MMG75H060XB6EN

NTC CHARACTERISTICS ($T_C = 25^\circ\text{C}$ unless otherwise specified)

| Symbol | Parameter/Test Conditions | | Min. | Typ. | Max. | Unit |
|-------------|---------------------------------------------------------------|--------------------------|------|------|------|------------------|
| R_{25} | Resistance | $T_C = 25^\circ\text{C}$ | | 5 | | $\text{K}\Omega$ |
| $B_{25/50}$ | $R_2 = R_{25} \exp [B_{25/50}(1/T_2 - 1/(298.15 \text{ K}))]$ | | | 3375 | | K |

MODULE CHARACTERISTICS ($T_C = 25^\circ\text{C}$ unless otherwise specified)

| Symbol | Parameter/Test Conditions | | Values | Unit |
|------------|-----------------------------|----------------------------|---------|------------------|
| T_{Jmax} | Max. Junction Temperature | Inverter, Brake-Chopper | 175 | $^\circ\text{C}$ |
| | | Rectifier | 150 | |
| T_{Jop} | Operating Temperature | | -40~150 | |
| T_{stg} | Storage Temperature | | -40~125 | |
| V_{isol} | Isolation Breakdown Voltage | AC, 50Hz(R.M.S), t=1minute | 3000 | V |
| CTI | Comparative Tracking Index | | >200 | |
| Md | Mounting Torque | Recommended (M5) | 2.5~5 | Nm |
| Weight | | | 180 | g |

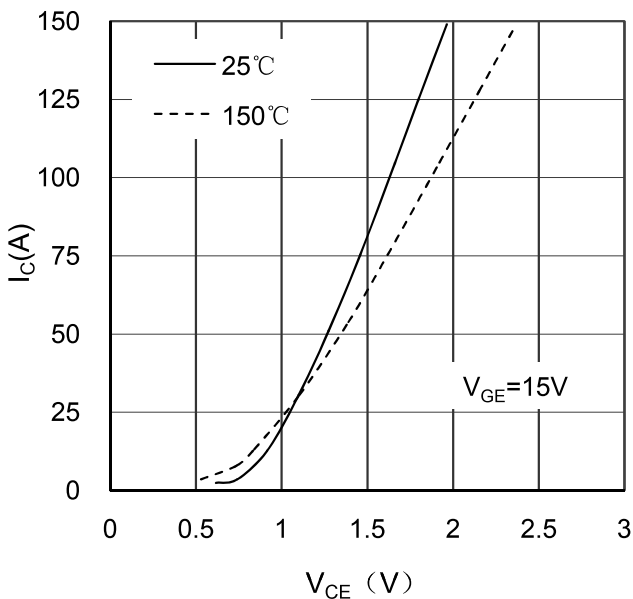

Figure 1. Typical Output Characteristics IGBT-inverter

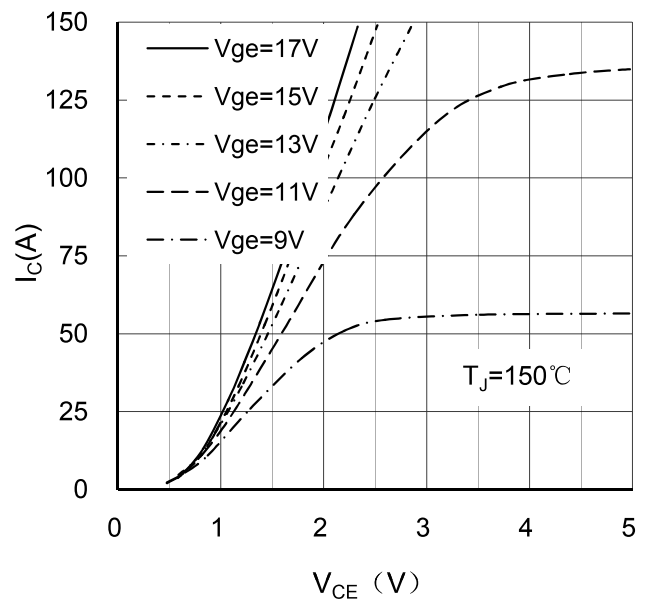

Figure 2. Typical Output Characteristics IGBT-inverter

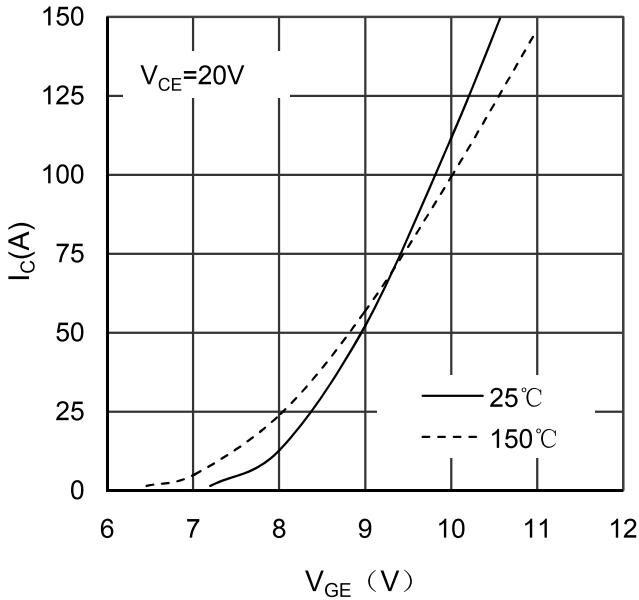

Figure 3. Typical Transfer characteristics IGBT-inverter

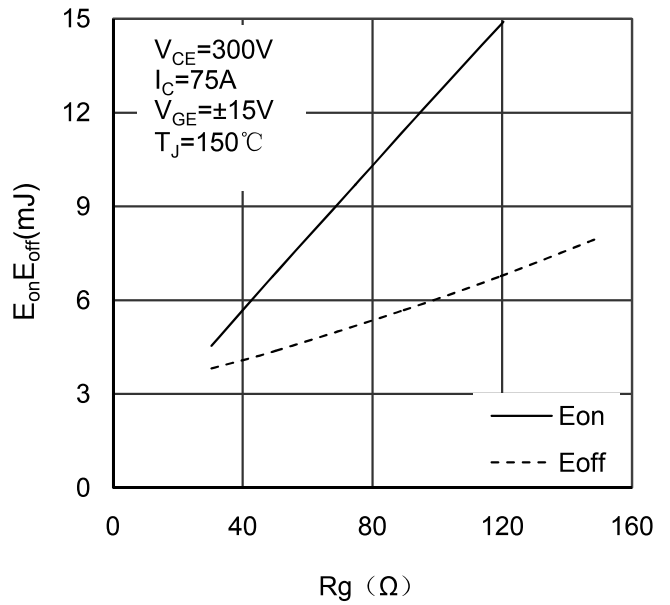

Figure 4. Switching Energy vs Gate Resistor IGBT-inverter

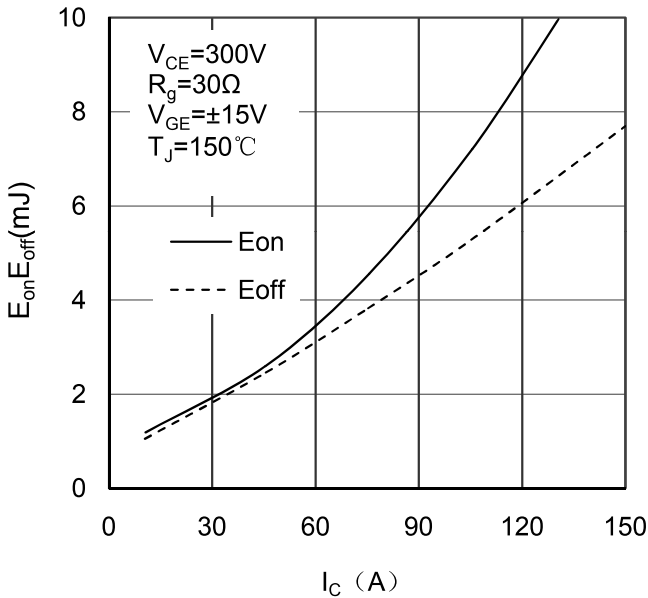

Figure 5. Switching Energy vs Collector Current IGBT-inverter

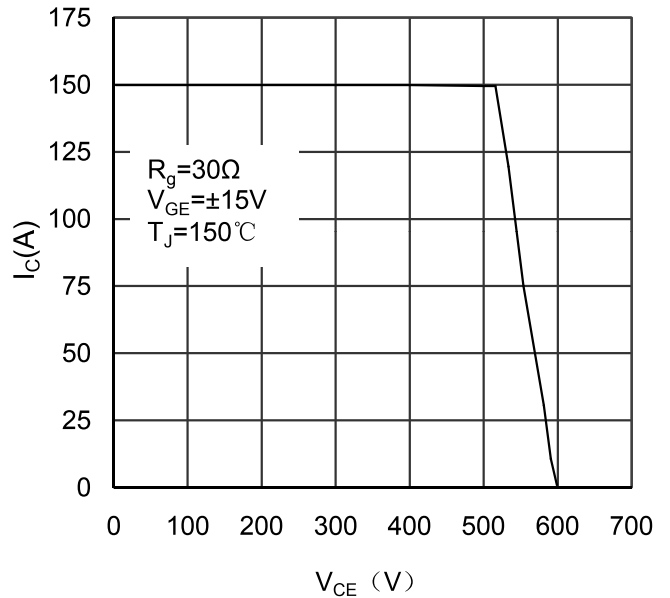

Figure 6. Reverse Biased Safe Operating Area IGBT-inverter

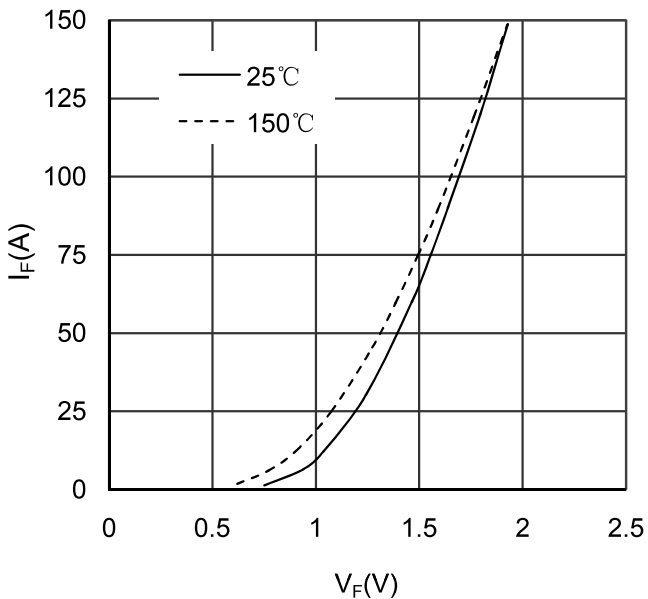

Figure 7. Diode Forward Characteristics Diode -inverter

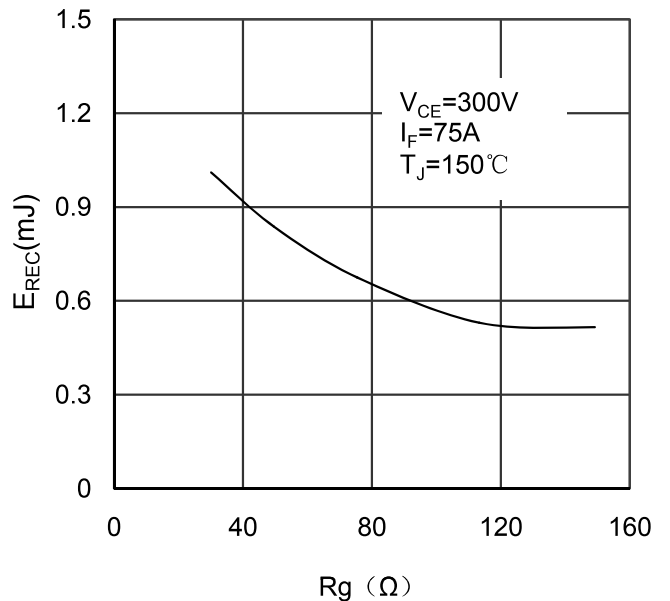

Figure 8. Switching Energy vs Gate Resistor Diode -inverter

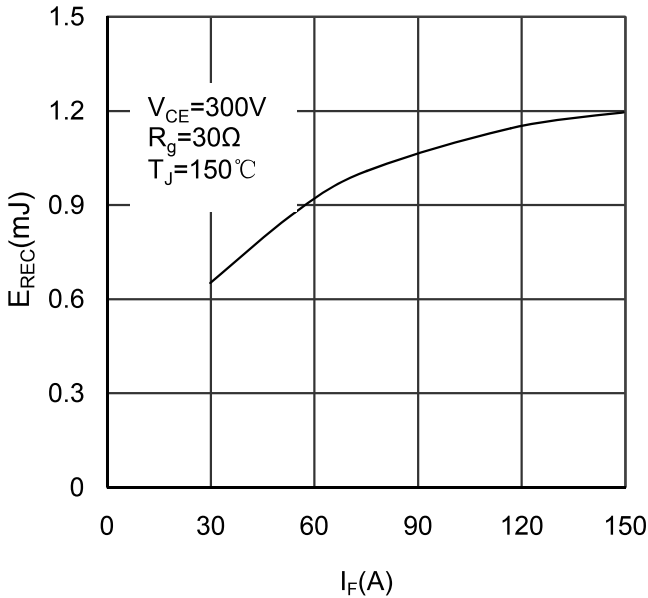

Figure 9. Switching Energy vs Forward Current Diode-inverter

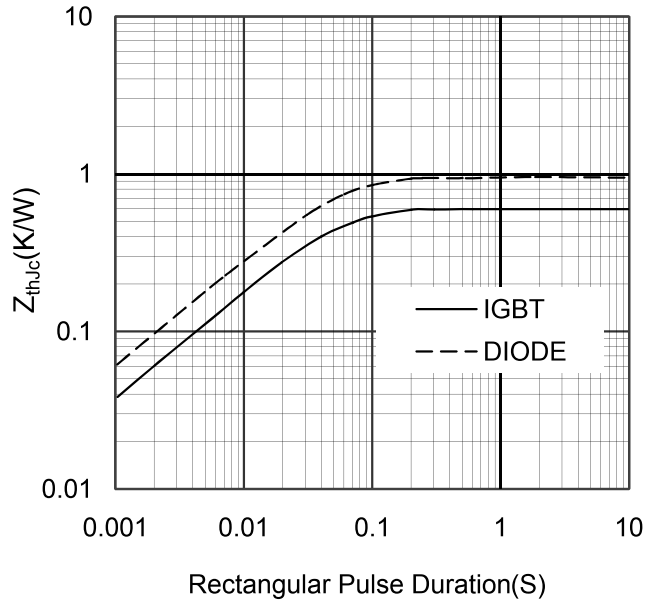

Figure 10. Transient Thermal Impedance of Diode and IGBT-inverter

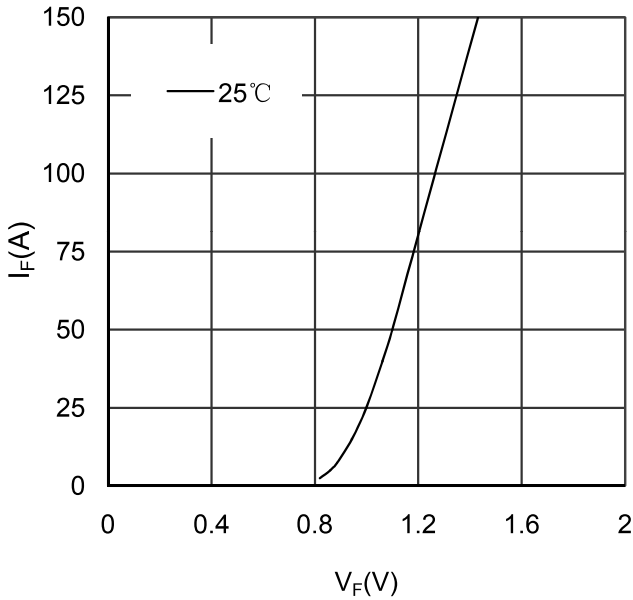

Figure 11. Diode Forward Characteristics Diode-rectifier

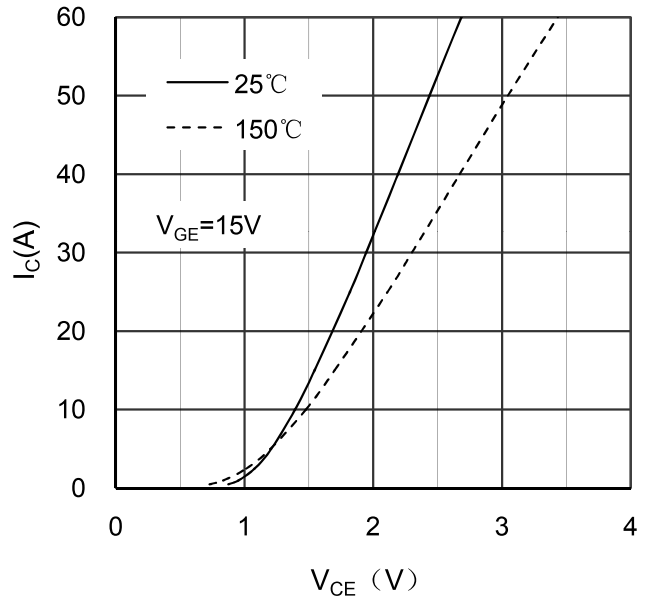

Figure 12. Typical Output Characteristics IGBT-brake chopper

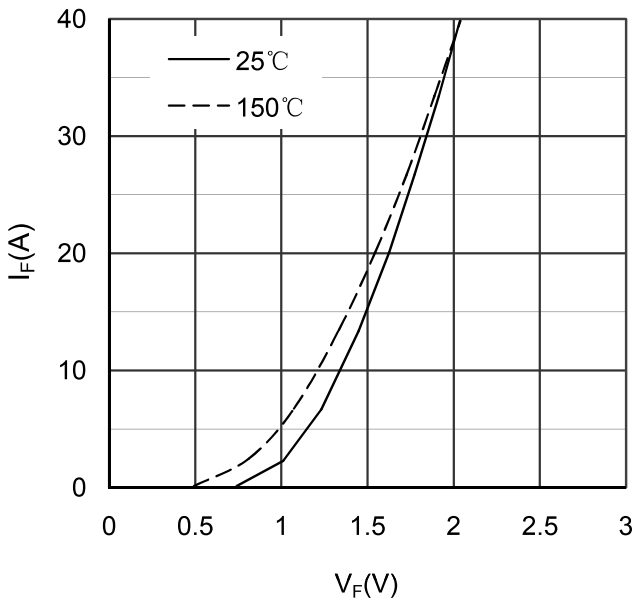

Figure 13. Diode Forward Characteristics Diode-brake chopper

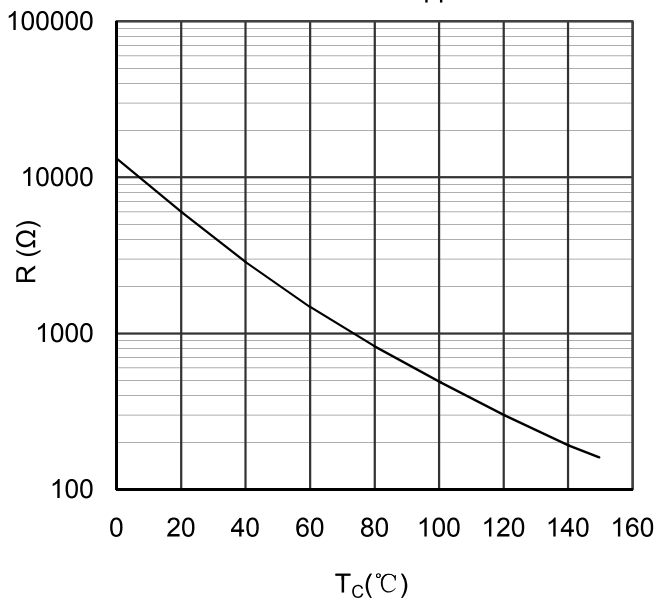

Figure 14. NTC Characteristics

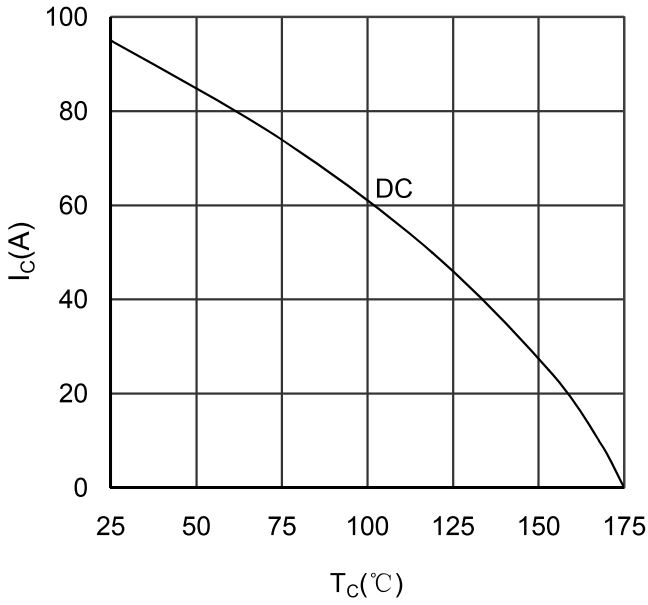

Figure 15. Collector Current vs Case temperature IGBT-inverter

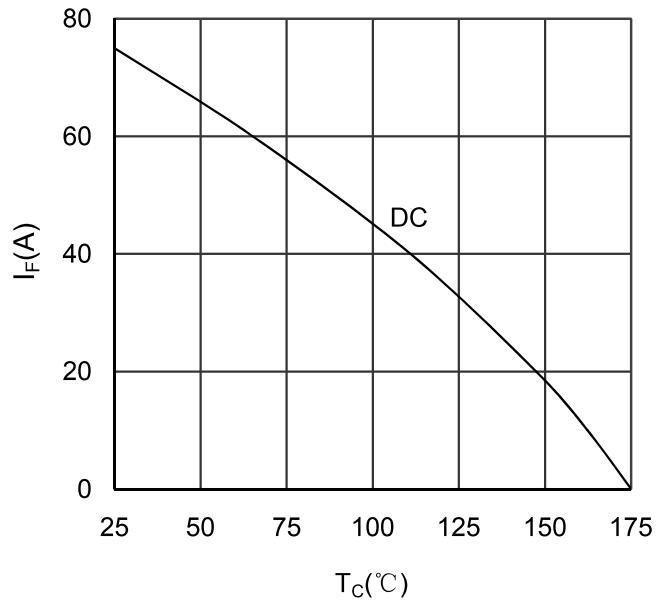

Figure 16. Forward current vs Case temperature Diode-inverter

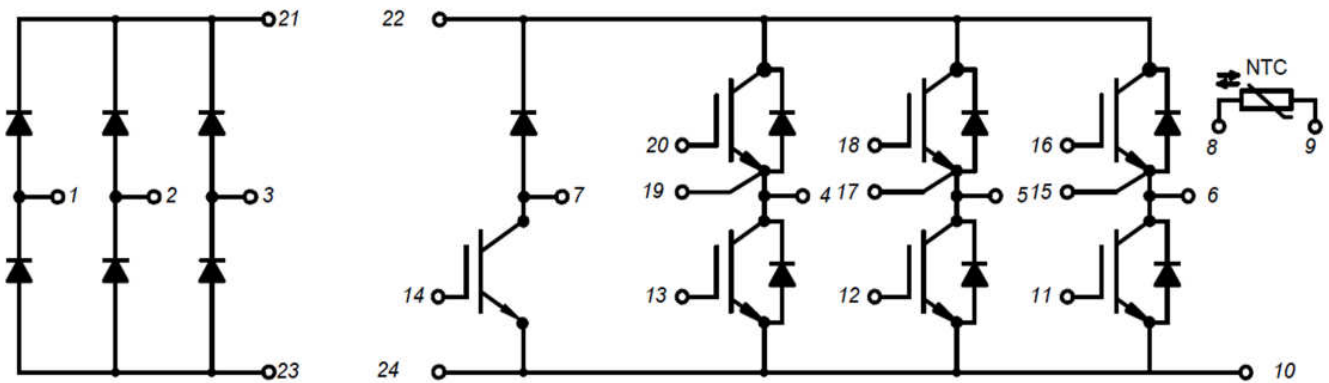
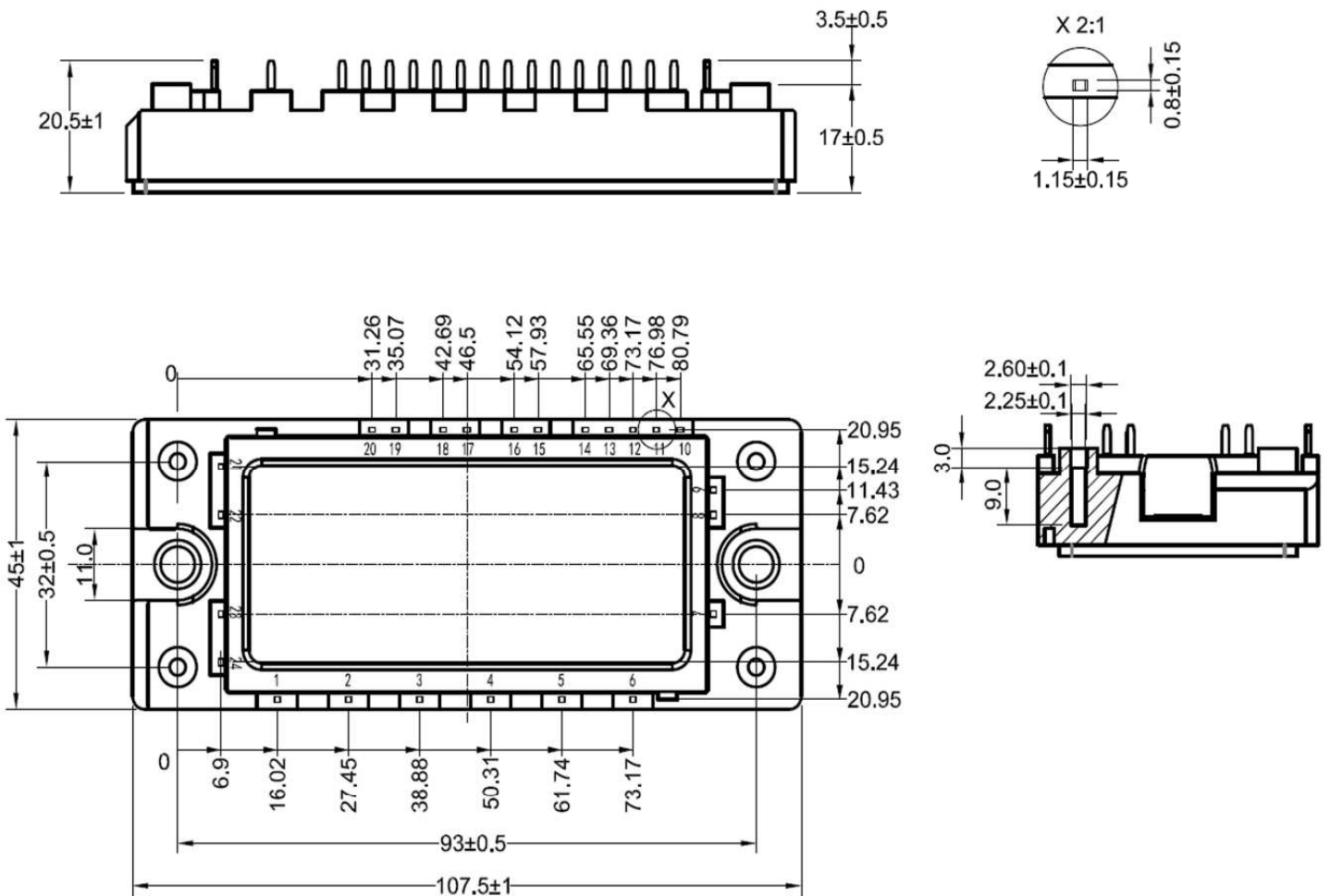

Figure 17. Circuit Diagram



Dimensions in (mm)
Figure 18. Package Outline