

PRODUCT FEATURES

- IGBT CHIP(Trench+FS)
- Low saturation voltage and positive temperature coefficient
- Fast switching and short tail current
- Free wheeling diodes with fast and soft reverse recovery
- Temperature sense included

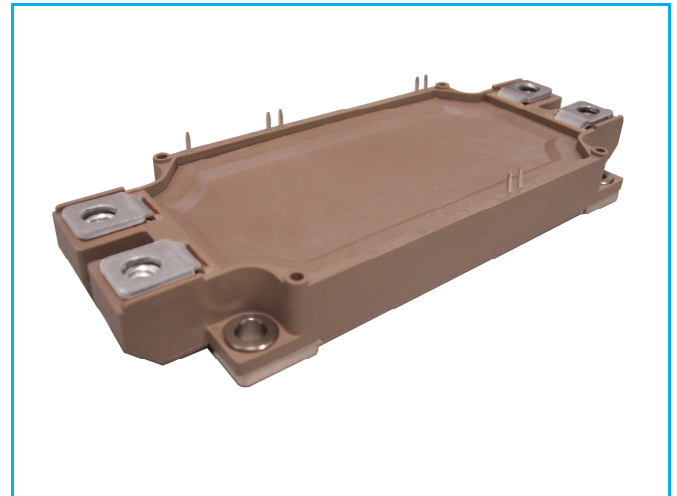

APPLICATIONS

- AC motor control
- Motion/servo control
- Inverter and power supplies
- Photovoltaic/Fuel cell

IGBT-ABSOLUTE MAXIMUM RATINGS ($T_C=25^\circ\text{C}$ unless otherwise specified)

Symbol	Parameter/Test Conditions		Values	Unit
V_{CES}	Collector Emitter Voltage	$T_J=25^\circ\text{C}$	1200	V
V_{GES}	Gate Emitter Voltage		± 20	
I_C	DC Collector Current	$T_C=25^\circ\text{C}, T_{Jmax}=175^\circ\text{C}$	910	A
		$T_C=100^\circ\text{C}, T_{Jmax}=175^\circ\text{C}$	600	
I_{CM}	Repetitive Peak Collector Current	$t_p=1\text{ms}$	1200	
P_{tot}	Power Dissipation Per IGBT	$T_C=25^\circ\text{C}, T_{Jmax}=175^\circ\text{C}$	2941	W

Diode-ABSOLUTE MAXIMUM RATINGS ($T_C=25^\circ\text{C}$ unless otherwise specified)

Symbol	Parameter/Test Conditions		Values	Unit
V_{RRM}	Repetitive Reverse Voltage	$T_J=25^\circ\text{C}$	1200	V
$I_{F(AV)}$	Average Forward Current		600	A
I_{FRM}	Repetitive Peak Forward Current	$t_p=1\text{ms}$	1200	
I^2t		$T_J=150^\circ\text{C}, t=10\text{ms}, V_R=0\text{V}$	100	kA^2s

MacMic Science & Technology Co., Ltd.

Add: #18, Hua Shan Zhong Lu, New District, Changzhou City, Jiangsu Province, P. R. of China

Tel.: +86-519-85163708 Fax: +86-519-85162291 Post Code: 213022 Website: www.macmicst.com

MMG600WB120B6T6

IGBT-inverter

ELECTRICAL CHARACTERISTICS ($T_C = 25^\circ\text{C}$ unless otherwise specified)

Symbol	Parameter/Test Conditions		Min.	Typ.	Max.	Unit
$V_{GE(th)}$	Gate Emitter Threshold Voltage	$V_{CE}=V_{GE}, I_C=15\text{mA}$	5.0	5.8	6.5	V
$V_{CE(sat)}$	Collector Emitter Saturation Voltage	$I_C=600\text{A}, V_{GE}=15\text{V}, T_J=25^\circ\text{C}$		1.7	2.3	
		$I_C=600\text{A}, V_{GE}=15\text{V}, T_J=125^\circ\text{C}$		1.9		
		$I_C=600\text{A}, V_{GE}=15\text{V}, T_J=150^\circ\text{C}$		1.95		
I_{CES}	Collector Leakage Current	$V_{CE}=1200\text{V}, V_{GE}=0\text{V}, T_J=25^\circ\text{C}$			1	mA
		$V_{CE}=1200\text{V}, V_{GE}=0\text{V}, T_J=150^\circ\text{C}$			10	
I_{GES}	Gate Leakage Current	$V_{CE}=0\text{V}, V_{GE}=\pm 20\text{V}, T_J=25^\circ\text{C}$	-400		400	nA
R_{Gint}	Integrated Gate Resistor			0.4		Ω
Q_g	Gate Charge	$V_{CE}=600\text{V}, I_C=600\text{A}, V_{GE}=15\text{V}$		3.1		μC
C_{ies}	Input Capacitance	$V_{CE}=25\text{V}, V_{GE}=0\text{V}, f=1\text{MHz}$		400		nF
C_{res}	Reverse Transfer Capacitance				1.3	
$t_{d(on)}$	Turn on Delay Time	$V_{CC}=600\text{V}, I_C=600\text{A}$ $R_G=1.5\Omega,$ $V_{GE}=\pm 15\text{V},$ Inductive Load	$T_J=25^\circ\text{C}$		140	ns
			$T_J=150^\circ\text{C}$		160	ns
t_r	Rise Time	$V_{GE}=\pm 15\text{V},$ Inductive Load	$T_J=25^\circ\text{C}$		70	ns
			$T_J=150^\circ\text{C}$		80	ns
$t_{d(off)}$	Turn off Delay Time	$V_{CC}=600\text{V}, I_C=600\text{A}$ $R_G=1.5\Omega,$ $V_{GE}=\pm 15\text{V},$ Inductive Load	$T_J=25^\circ\text{C}$		400	ns
			$T_J=150^\circ\text{C}$		450	ns
t_f	Fall Time	$V_{GE}=\pm 15\text{V},$ Inductive Load	$T_J=25^\circ\text{C}$		200	ns
			$T_J=150^\circ\text{C}$		320	ns
E_{on}	Turn on Energy	$V_{CC}=600\text{V}, I_C=600\text{A}$ $R_G=1.5\Omega,$ $V_{GE}=\pm 15\text{V},$ Inductive Load	$T_J=25^\circ\text{C}$		43	mJ
			$T_J=125^\circ\text{C}$		63	mJ
			$T_J=150^\circ\text{C}$		70	mJ
E_{off}	Turn off Energy	$V_{GE}=\pm 15\text{V},$ Inductive Load	$T_J=25^\circ\text{C}$		64	mJ
			$T_J=125^\circ\text{C}$		74.5	mJ
			$T_J=150^\circ\text{C}$		81	mJ
I_{SC}	Short Circuit Current	$tp_{sc} \leq 10\mu\text{s}, V_{GE}=15\text{V}$ $T_J=150^\circ\text{C}, V_{CC}=800\text{V}$		2800		A
R_{thJC}	Junction to Case Thermal Resistance (Per IGBT)				0.051	K/W

Diode-inverter

ELECTRICAL CHARACTERISTICS ($T_C = 25^\circ\text{C}$ unless otherwise specified)

Symbol	Parameter/Test Conditions		Min.	Typ.	Max.	Unit
V_F	Forward Voltage	$I_F=600\text{A}, V_{GE}=0\text{V}, T_J=25^\circ\text{C}$		1.9	2.3	V
		$I_F=600\text{A}, V_{GE}=0\text{V}, T_J=125^\circ\text{C}$		1.8		
		$I_F=600\text{A}, V_{GE}=0\text{V}, T_J=150^\circ\text{C}$		1.75		
t_{rr}	Reverse Recovery Time	$I_F=600\text{A}, V_R=600\text{V}$ $dI_F/dt=-4700\text{A}/\mu\text{s}$ $T_J=150^\circ\text{C}$		500		ns
I_{RRM}	Max. Reverse Recovery Current			440		A
Q_{RR}	Reverse Recovery Charge			100		μC
E_{rec}	Reverse Recovery Energy			48		mJ
R_{thJCD}	Junction to Case Thermal Resistance (Per Diode)				0.072	K/W

MMG600WB120B6T6

NTC CHARACTERISTICS ($T_C=25^\circ\text{C}$ unless otherwise specified)

Symbol	Parameter/Test Conditions	Min.	Typ.	Max.	Unit
R_{25}	Resistance $T_C=25^\circ\text{C}$		5		k Ω
$B_{25/50}$	$R_2 = R_{25} \exp [B_{25/50}(1/T_2 - 1/(298.15 \text{ K}))]$		3375		K

MODULE CHARACTERISTICS ($T_C=25^\circ\text{C}$ unless otherwise specified)

Symbol	Parameter/Test Conditions	Values	Unit	
T_{Jmax}	Max. Junction Temperature	175	$^\circ\text{C}$	
T_{Jop}	Operating Temperature	-40~150		
T_{stg}	Storage Temperature	-40~125		
V_{isol}	Isolation Breakdown Voltage	AC, 50Hz(R.M.S), t=1minute	3000	V
CTI	Comparative Tracking Index		> 225	
Torque	to heatsink	Recommended (M5)	2.5~5	Nm
	to terminal	Recommended (M6)	3~5	Nm
Weight			350	g

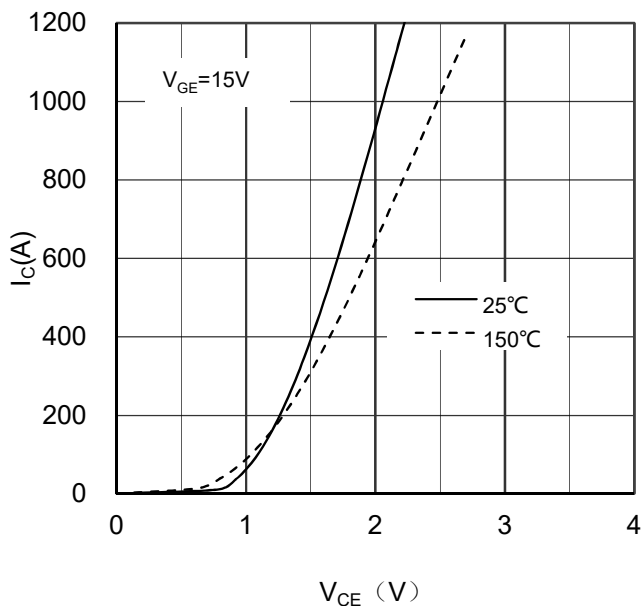

Figure 1. Typical Output Characteristics IGBT

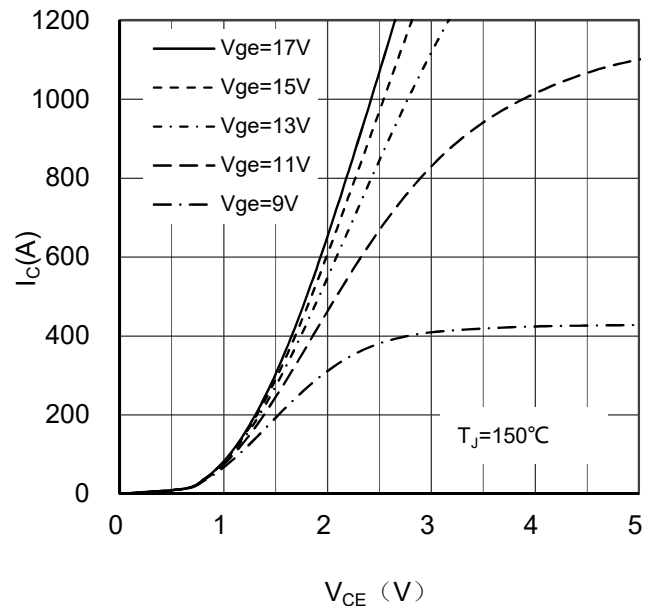

Figure 2. Typical Output Characteristics IGBT

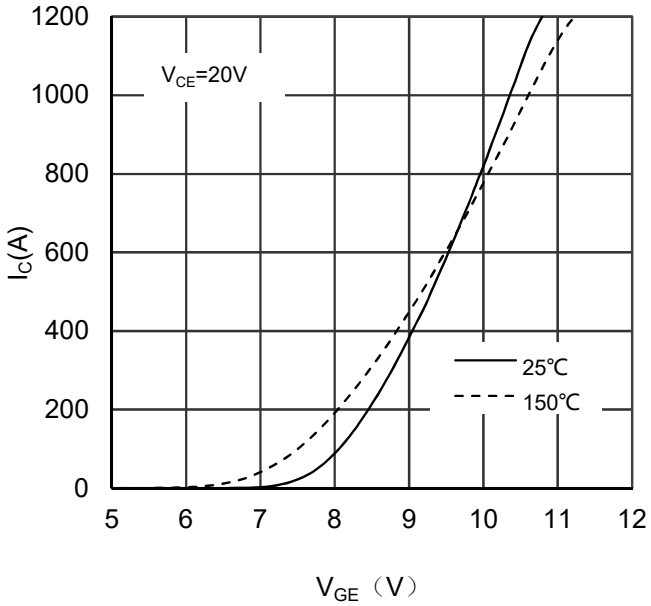

Figure 3. Typical Transfer characteristics IGBT

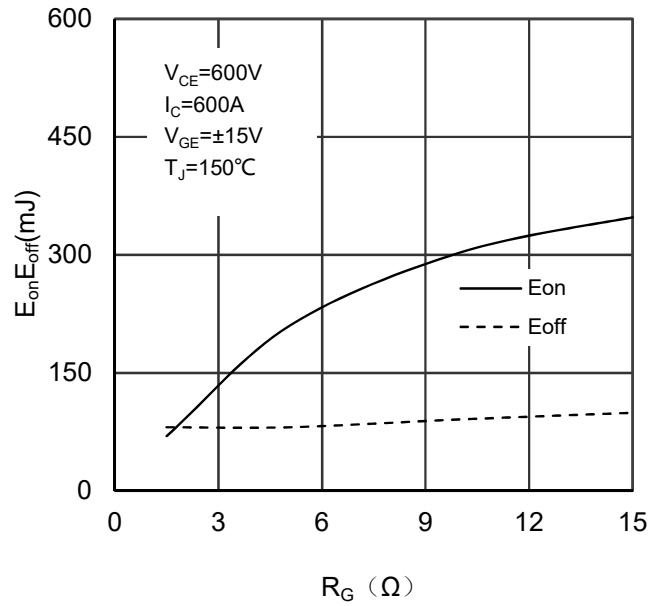

Figure 4. Switching Energy vs Gate Resistor IGBT

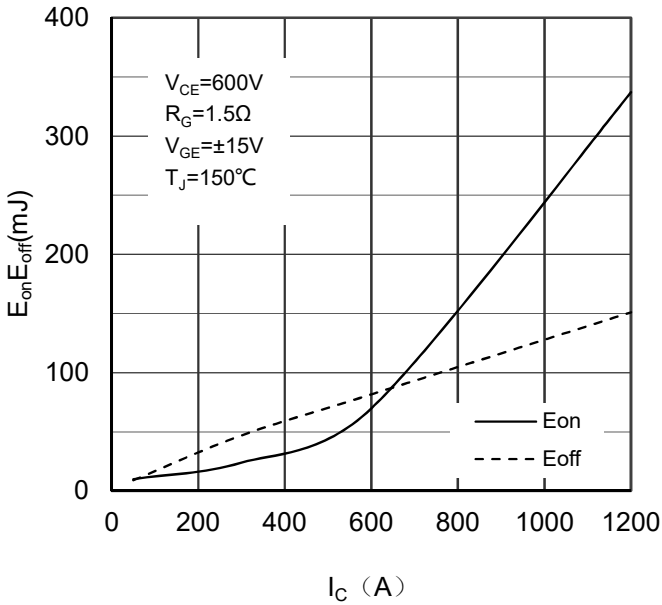

Figure 5. Switching Energy vs Collector Current IGBT

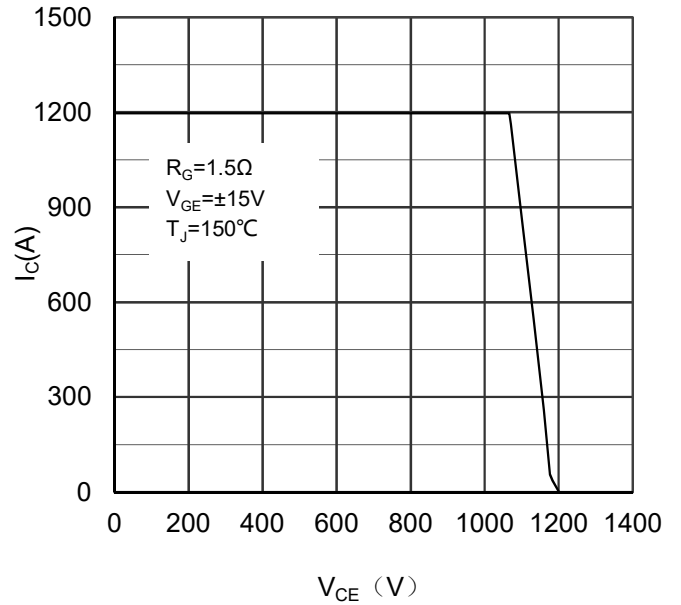

Figure 6. Reverse Biased Safe Operating Area IGBT

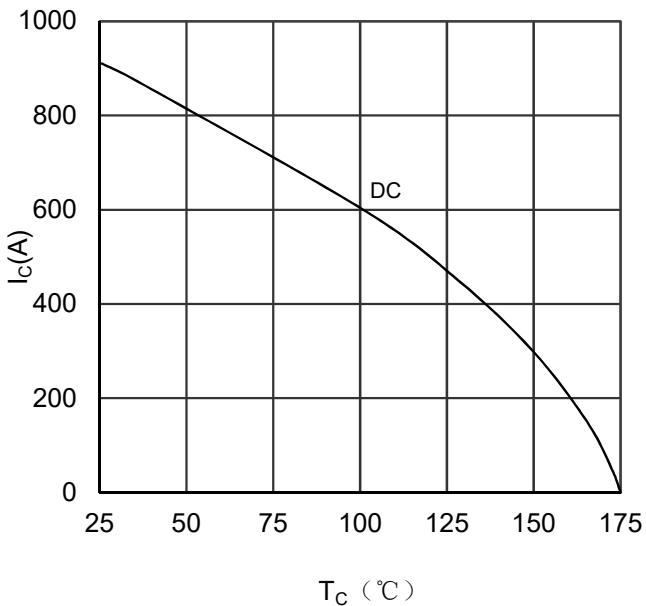

Figure 7. Collector Current vs Case temperature IGBT

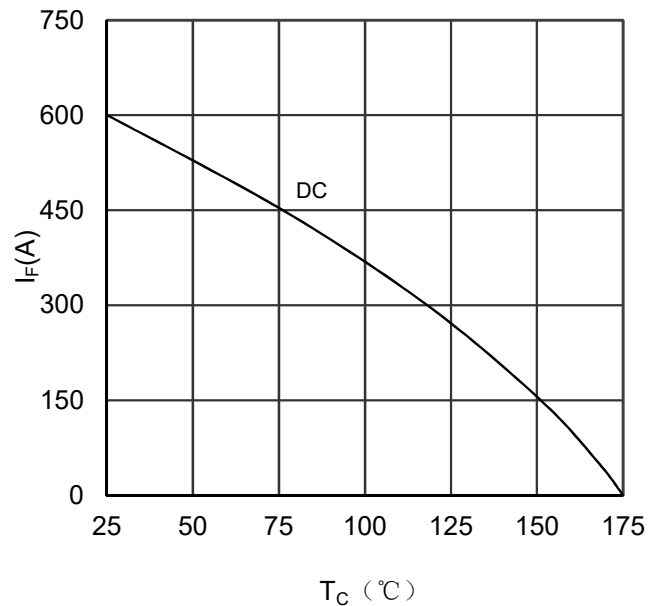

Figure 8. Forward current vs Case temperature Diode

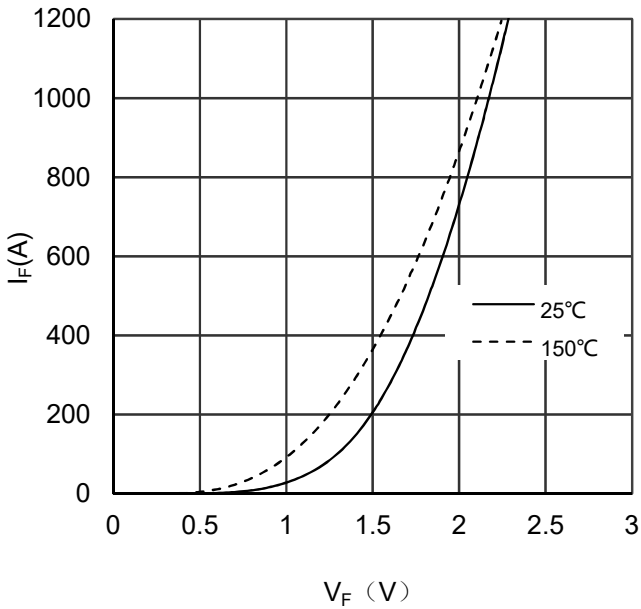

Figure 9. Diode Forward Characteristics Diode

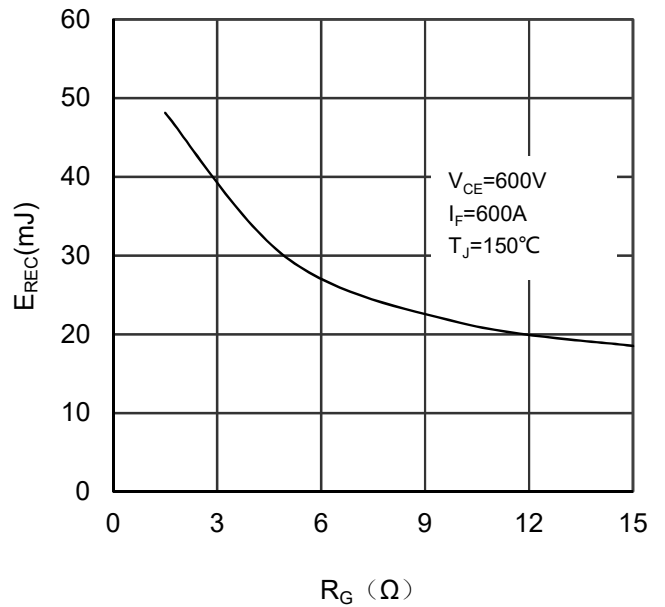

Figure 10. Switching Energy vs Gate Resistor Diode

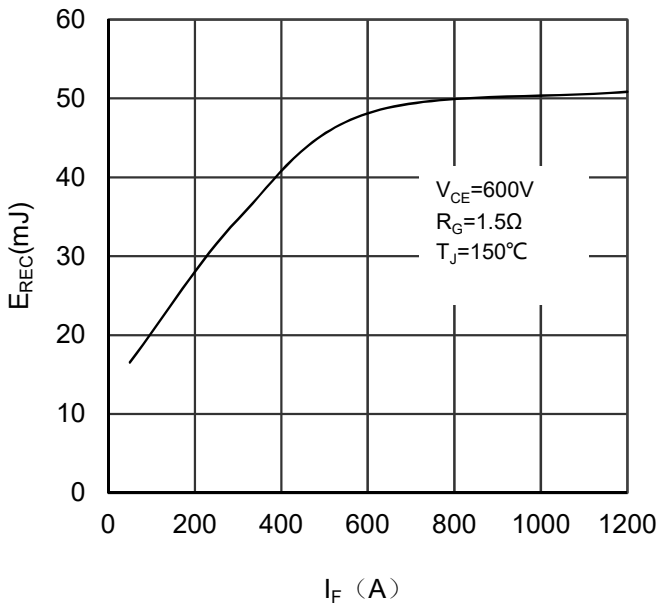

Figure 11. Switching Energy vs Forward Current Diode

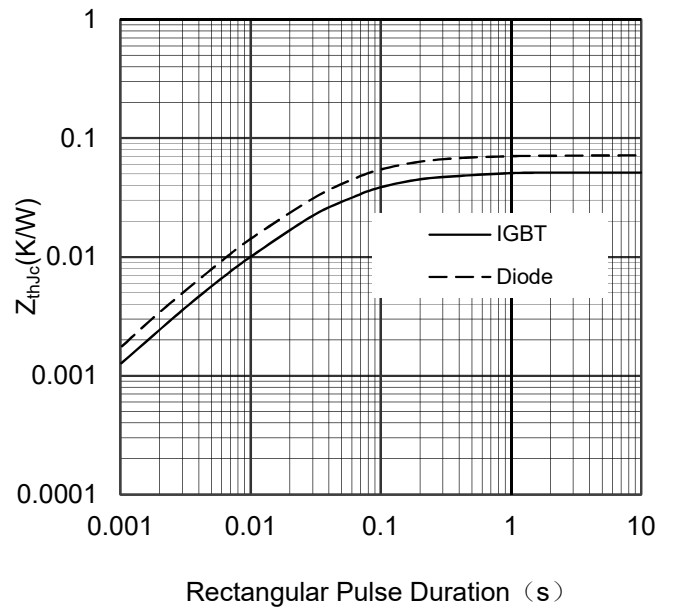

Figure 12. Transient Thermal Impedance of Diode and IGBT

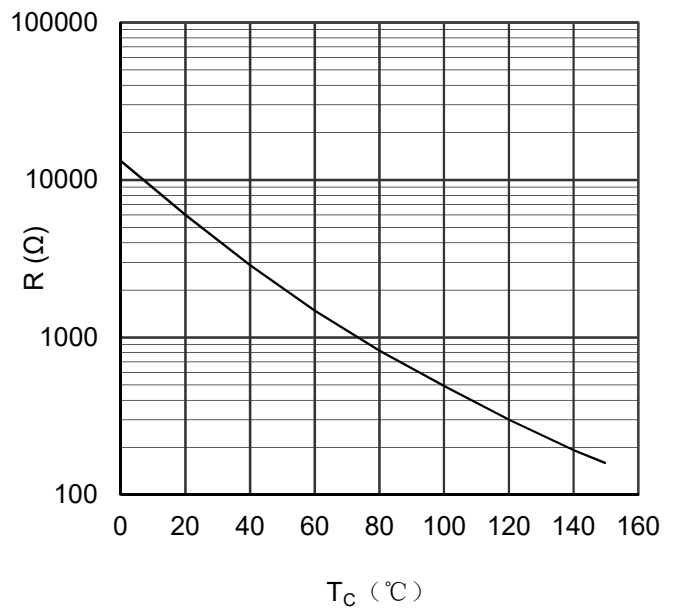

Figure 13. NTC Characteristics

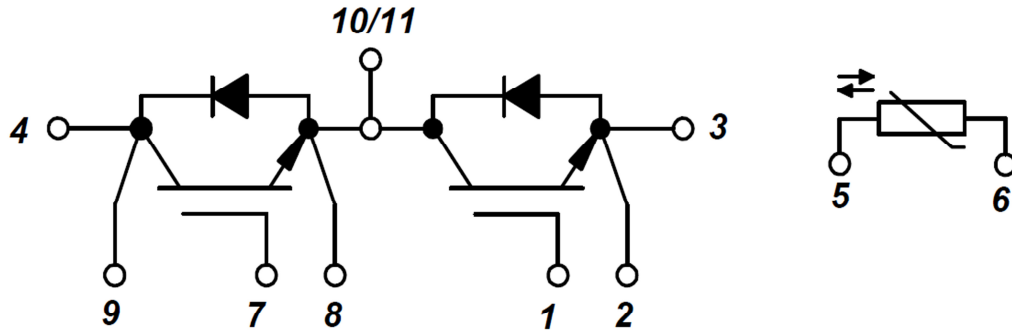
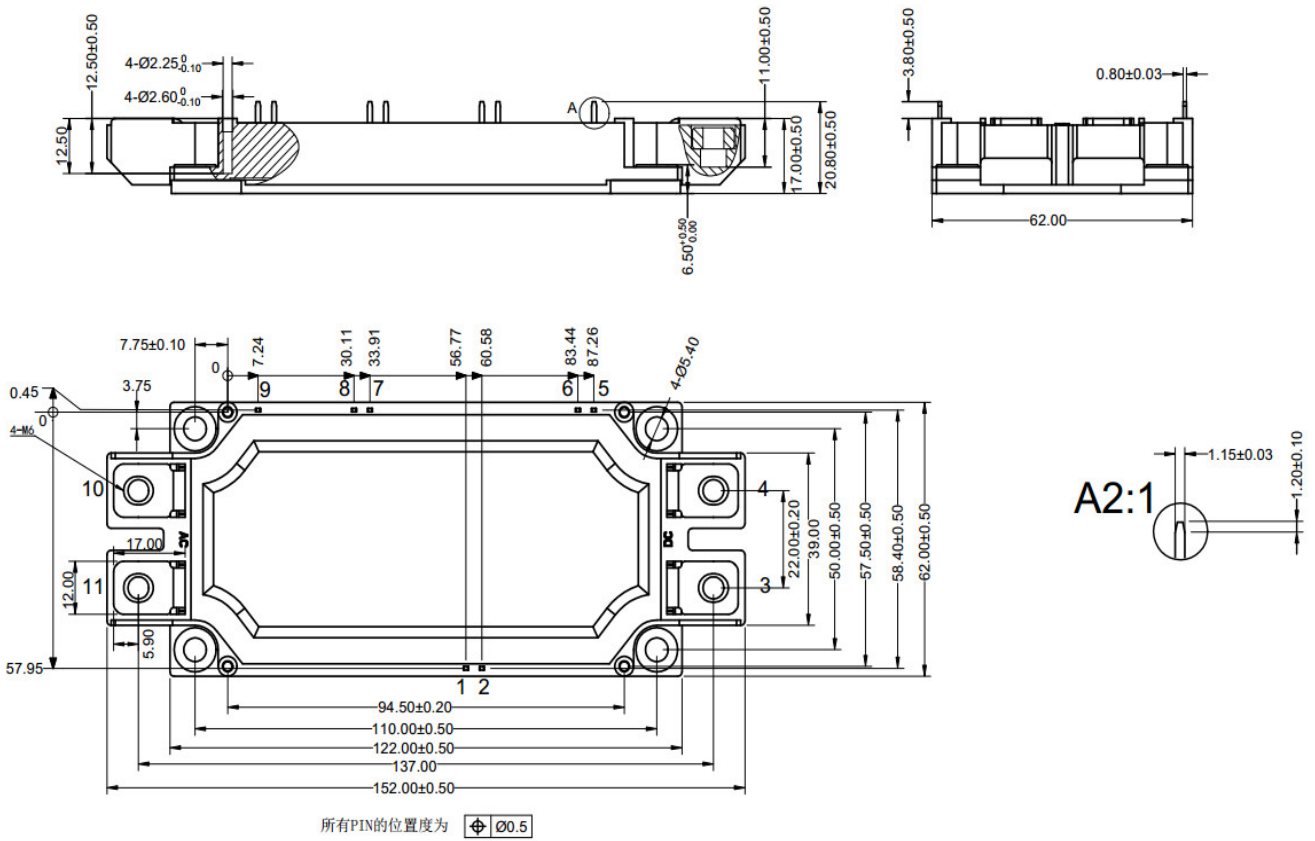

Figure 14. Circuit Diagram



Dimensions in (mm)
Figure 15. Package Outline